

1 YEAR
WARRANTY

Ω OMEGA® **User's Guide**



Shop online at
***omega.com*SM**

e-mail: info@omega.com
For latest product manuals:
www.omegamanual.info

FMA-2600A Series **Mass Flow Controllers**



omega.com info@omega.com

Servicing North America:

U.S.A.:

Omega Engineering, Inc., One Omega Drive, P.O. Box 4047

Stamford, CT 06907-0047 USA

Toll-Free: 1-800-826-6342 (USA & Canada only)

Customer Service: 1-800-622-2378 (USA & Canada only)

Engineering Service: 1-800-872-9436 (USA & Canada only)

Tel: (203) 359-1660

Fax: (203) 359-7700

e-mail: info@omega.com

For Other Locations Visit omega.com/worldwide

Thank you for purchasing an Omega FMA-2600A Series Gas Flow Controller.

Please take the time to read the information contained in this manual. This will help to ensure that you get the best possible service from your instrument. This manual covers the following Omega instruments:

FMA-2600A Mass Gas Flow Controllers

FMA-LP2600A Low Pressure Drop Mass Gas Flow Controllers

FMA-2600A-LSS Mass Gas Flow Controllers

FMA-2600A-LSS Flow Controllers are for use with certain aggressive gases (see page 67)

FMA-2600A-P Mass Gas Flow Controllers

FMA-2600A-P Flow Controllers have an integrated shut-off valve and are built for use with applications that require tight shut-off (see pages 30 and 65).

Unless otherwise noted, the instructions in this manual are applicable to all of the above instruments.

Full specifications for each device can be found on pages 56 through 71.



Please contact Omega at 800-826-6342 if you have any questions regarding the use or operation of this device.

TABLE OF CONTENTS	Page
GETTING STARTED	6
MOUNTING	6
PLUMBING	7
PRESSURE	7
POWER AND SIGNAL CONNECTIONS	8
INPUT SIGNALS	9
Analog Input Signal	9
RS232 / RS485 Digital Input Signal	10
OUTPUT SIGNALS	11
RS232 / RS485 Digital Output Signal	11
Standard Voltage (0-5 Vdc) Output Signal	11
Optional 0-10 Vdc Output Signal	11
Optional Current (4-20 mA) Output Signal	11
Optional 2nd Analog Output Signal	11
Information for Omega TFT (Color Display) Instruments	13
DISPLAYS AND MENUS	14
MAIN	15
Gas Absolute Pressure	15
Gas Temperature	15
Set-Pt.	15
Volumetric Flow Rate	15
Mass Flow Rate	16
<i>Flashing Error Message</i>	16
SELECT MENU	17
CONTROL SETUP	18
Set-Point Source	18
Loop Variable	19
On / Off Auto-tare	19
PID Tuning	20
GAS SELECT	22
Composer	23
COMMUNICATION SELECT	25
Unit ID	25
Baud	25
MISCELLANEOUS	26
MISC1	26
Zero Band	26
Pressure Averaging	26
Flow Averaging	26
LCD Contrast	26
MISC2	27
STP/NTP	27
DIAG TEST	28
Rotate Display	28
DEVICE UNITS	28
MANUFACTURER DATA	29

TABLE OF CONTENTS	Page
FMA-2600A-P Controller Operating Notes	30
RS232 or RS485 Output and Input	31
Configuring HyperTerminal®	31
Streaming Mode	31
Changing from Streaming to Polling Mode	32
Sending a Set-Point via RS232 or RS485	32
To adjust the P & D terms via RS232 or RS485	33
Gas Select	34
Creating and Deleting Gas Mixtures using RS232 or RS485	35
Collecting Data	36
Data Format	36
Sending a Simple Script File to HyperTerminal®	37
Operating Principle	37
Standard Gas Data Tables	38
Gas Lists with Viscosities, Densities and Compressibilities	39
Supported Units List	47
Troubleshooting	49
Maintenance and Recalibration	51
Option: Totalizing Mode	52
Batch Processing	53
Accessory: FMA1600-MDB Multi-Drop Box	54
Accessories	55
FMA-2600A Technical Specifications	56
FMA-LP2600A Technical Specifications	61
FMA-2600A-P and FMA-2600A-P-LSS Technical Specifications	65
FMA-2600A-LSS Technical Specifications	67
Eight Pin Mini-DIN Pin-Out	72
DB15 Pin-Out Diagrams	73
Warranty / Returns	See Inside of Back Cover

GETTING STARTED

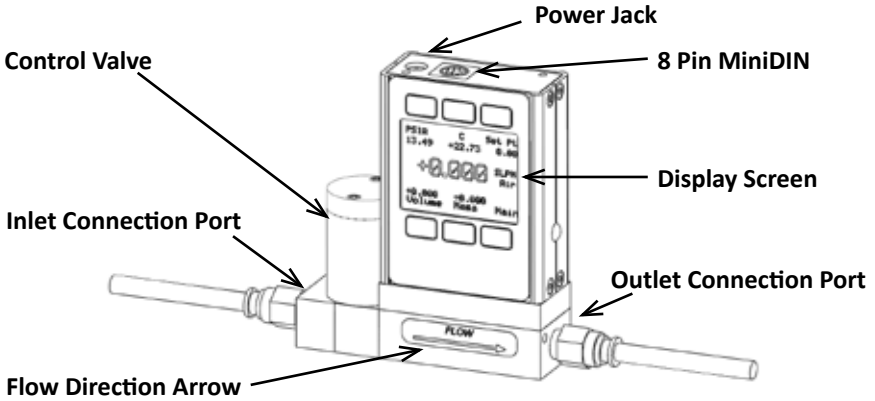

Small Valve Mass Flow Controller shown with an upstream valve configuration and connection port fittings

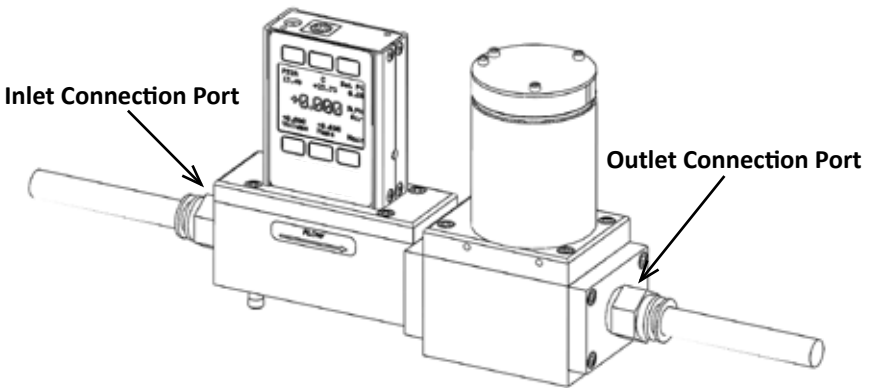

Large Valve Mass Flow Controller shown with a downstream valve configuration and connection port fittings

MOUNTING

FMA-2600A Gas Flow Controllers have holes on the bottom for mounting to flat panels. See pages 56 - 71.

Small valve controllers can usually be mounted in any position.

Large valve controllers should be mounted so that the valve cylinder is vertical and upright. Mounting a large valve controller in another position increases the risk of leakage when the controller is being held closed by the spring force.

No straight runs of pipe are required upstream or downstream of the controller.

PLUMBING



Your controller is shipped with plastic plugs fitted in the port openings. To lessen the chance of contaminating the flow stream do not remove these plugs until you are ready to install the device.

Make sure that the gas will flow in the direction indicated by the flow arrow.

Standard FMA-2600A Gas Flow Controllers have female inlet and outlet port connections. Welded VCR and other specialty fittings may have male ports.

The inlet and outlet port sizes (process connections) for different flow ranges are shown on pages 56 - 71.

Controllers with M5 (10-32) ports have O-ring face seals and require no sealant or tape. Do not use tape with welded or o-ring fittings.

For non-M5 (10-32) ports use thread sealing PTFE tape to prevent leakage around the port threads.

Do not wrap the first two threads. This will minimize the possibility of getting tape into the flow stream and flow body.



Do not use pipe dopes or sealants on the process connections as these compounds can cause permanent damage to the controller should they get into the flow stream.

When changing fittings, carefully clean any tape or debris from the port threads.

We recommend the use of in-line sintered filters to prevent large particulates from entering the measurement head of the instrument. Suggested maximum particulate sizes are as follows:

5 microns for units with FS flow ranges of 0-1 sccm or less.

20 microns for units with FS flow ranges between 0-2 sccm and 0-1 slpm.

50 microns for units with FS flow ranges of 0-1 slpm or more.

PRESSURE

Maximum operating line pressure is 145 psig (1 MPa).

If the line pressure is higher than 145 psig (1 MPa), use a pressure regulator upstream from the flow controller to reduce the pressure to 145 psig (1 MPa) or less.



CAUTION! EXCEEDING THE MAXIMUM SPECIFIED LINE PRESSURE MAY CAUSE PERMANENT DAMAGE TO THE SOLID-STATE DIFFERENTIAL PRESSURE TRANSDUCER.

POWER AND SIGNAL CONNECTIONS

Power can be supplied to your controller through either the power jack or the 8 pin Mini-DIN connector.

An AC to DC adapter which converts line AC power to DC voltage and current as specified below is required to use the power jack.

Small Valve controllers require a 12-30Vdc power supply with a 2.1 mm female positive center plug capable of supplying 250 mA. **NOTE:** 4-20mA analog output requires at least 15 Vdc.

Large Valve controllers require a 24-30 Vdc power supply with a 2.1 mm female positive center plug capable of supplying at least 750mA.

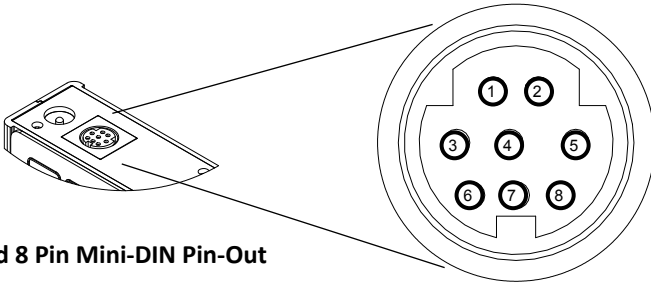

Standard 8 Pin Mini-DIN Pin-Out

Pin	Function	Mini-DIN cable color
1	Not Connected (or optional 4-20mA Primary Output Signal)	Black
2	Static 5.12 Vdc [or optional Secondary Analog Output (4-20mA, 5Vdc, 10Vdc) or Basic Alarm]	Brown
3	Serial RS232RX / RS485(-) Input Signal (receive)	Red
4	Meters = Remote Tare (Ground to Tare) Controllers = Analog Set-Point Input	Orange
5	Serial RS232TX / RS485(+) Output Signal (send)	Yellow
6	0-5 Vdc (or optional 0-10 Vdc) Output Signal	Green
7	Power In (as described above)	Blue
8	Ground (common for power, communications and analog signals)	Purple

Note: The above pin-out is applicable to all the flow meters and controllers with the Mini-DIN connector. The availability of different output signals depends on the options ordered. Optional configurations are noted on the unit's calibration sheet.



CAUTION! DO NOT CONNECT POWER TO PINS 1 THROUGH 6 AS PERMANENT DAMAGE CAN OCCUR!



It is common to mistake Pin 2 (labeled 5.12 Vdc Output) as the standard 0-5 Vdc analog output signal. In fact Pin 2 is normally a constant 5.12 Vdc that reflects the system bus voltage and can be used as a source for the set-point signal.



DB15 pin-outs see pages 73 to 79.

INPUT SIGNALS

Analog Input Signal

Apply analog input to Pin 4 as shown on page 8.

For DB15 pin-outs see pages 73 to 79.

Standard 0-5 Vdc is the standard analog input signal. Apply the 0-5 Vdc input signal to pin 4, with common ground on pin 8. The 5.12 Vdc output on pin 2 can be wired through a 50K ohm potentiometer and back to the analog input on pin 4 to create an adjustable 0-5 Vdc input signal source as shown below.

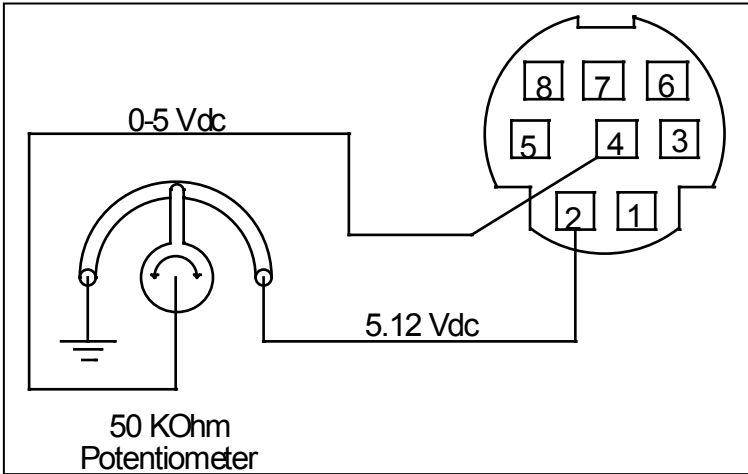

Simple method for providing set-point to controllers

Optional 0-10 Vdc: If specified at time of order, a 0-10 Vdc input signal can be applied to pin 4, with common ground on pin 8.

Optional 4-20 mA: If specified at time of order, a 4-20 mA input signal can be applied to pin 4, with common ground on pin 8.

NOTE: This is a current sinking device. The receiving circuit is essentially a 250 ohm resistor to ground.

NOTE: 4-20mA output requires at least 15 Vdc power input.



CAUTION! DO NOT CONNECT THIS DEVICE TO "LOOP POWERED" SYSTEMS, AS THIS WILL DESTROY PORTIONS OF THE CIRCUITRY AND VOID THE WARRANTY. IF YOU MUST INTERFACE WITH EXISTING LOOP POWERED SYSTEMS, ALWAYS USE A SIGNAL ISOLATOR AND A SEPARATE POWER SUPPLY.

RS232 / RS485 Digital Input Signal

To use the RS232 or RS485 input signal, connect the RS232 / RS485 Output Signal (Pin 5), the RS232 / RS485 Input Signal (Pin 3), and Ground (Pin 8) to your computer serial port as shown below. (See page 30 for details on accessing RS232 / RS485 input.)

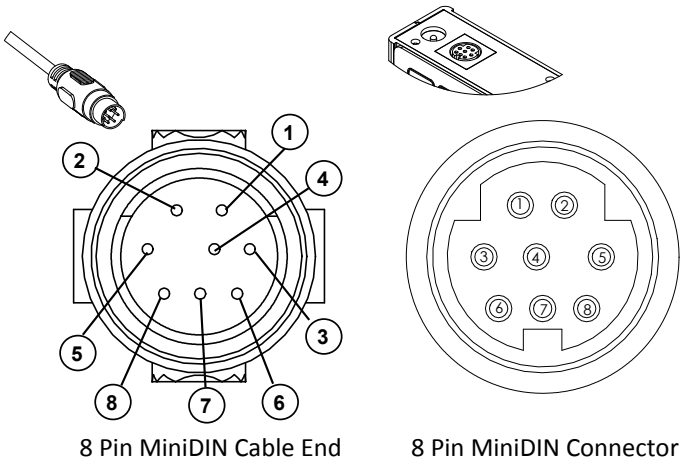
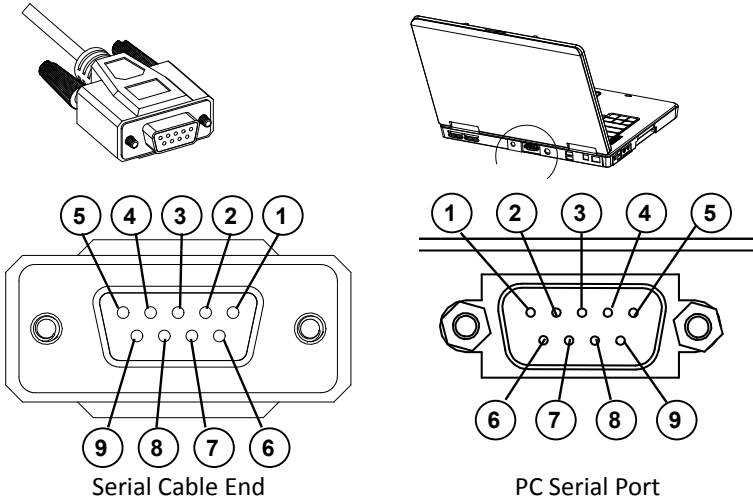

9 Pin Serial Connection		8 Pin MiniDIN Connection	
Pin	Function	Function	Pin
5	Ground	Ground	8
3	Transmit	Receive	3
2	Receive	Transmit	5

DB9 to Mini-DIN Connection for RS232 / RS485 Signals

OUTPUT SIGNALS

RS232 / RS485 Digital Output Signal

To use the RS232 or RS485 output signal, it is necessary to connect the RS232 / RS485 Output Signal (Pin 5), the RS232 / RS485 Input Signal (Pin 3), and Ground (Pin 8) to your computer serial port as shown on page 8. (See page 31 for details on accessing RS232 / RS485 output.)

Standard Voltage (0-5 Vdc) Output Signal

FMA-2600A flow controllers equipped with a 0-5 Vdc (optional 0-10 Vdc) will have this output signal available on Pin 6. This output is generally available in addition to other optionally ordered outputs. This voltage is usually in the range of 0.010 Vdc for zero flow and 5.0 Vdc for full-scale flow. The output voltage is linear over the entire range. Ground for this signal is common on Pin 8.

Optional 0-10 Vdc Output Signal

If your controller was ordered with a 0-10 Vdc output signal, it will be available on Pin 6. (See the Calibration Data Sheet that shipped with your controller to determine which output signals were ordered.) This voltage is usually in the range of 0.010 Vdc for zero flow and 10.0 Vdc for full-scale flow. The output voltage is linear over the entire range. Ground for this signal is common on Pin 8.

Optional Current (4-20 mA) Output Signal

If your controller was ordered with a 4-20 mA current output signal, it will be available on Pin 1. (See the Calibration Data Sheet that shipped with your controller to determine which output signals were ordered.) The current signal is 4 mA at 0 flow and 20 mA at the controller's full scale flow. The output current is linear over the entire range. Ground for this signal is common on Pin 8. (Current output units require 15-30Vdc power.)

Optional 2nd Analog Output Signal

You may specify an optional 2nd analog output on Pin 2 at time of order. (See the Calibration Data Sheet that shipped with your controller to determine which output signals were ordered.) This output may be a 0-5 Vdc, 0-10 Vdc, or 4-20 mA analog signal that can represent any measured parameter. With this optional output, a controller could output the mass flow rate (0-5 Vdc on pin 6) and the absolute pressure (0-5 Vdc on pin 2).



CAUTION! DO NOT CONNECT THIS DEVICE TO "LOOP POWERED" SYSTEMS, AS THIS WILL DESTROY PORTIONS OF THE CIRCUITRY AND VOID THE WARRANTY. IF YOU MUST INTERFACE WITH EXISTING LOOP POWERED SYSTEMS, ALWAYS USE A SIGNAL ISOLATOR AND A SEPARATE POWER SUPPLY.



CAUTION! DO NOT CONNECT THIS DEVICE TO "LOOP POWERED" SYSTEMS, AS THIS WILL DESTROY PORTIONS OF THE CIRCUITRY AND VOID THE WARRANTY. IF YOU MUST INTERFACE WITH EXISTING LOOP POWERED SYSTEMS, ALWAYS USE A SIGNAL ISOLATOR AND A SEPARATE POWER SUPPLY.

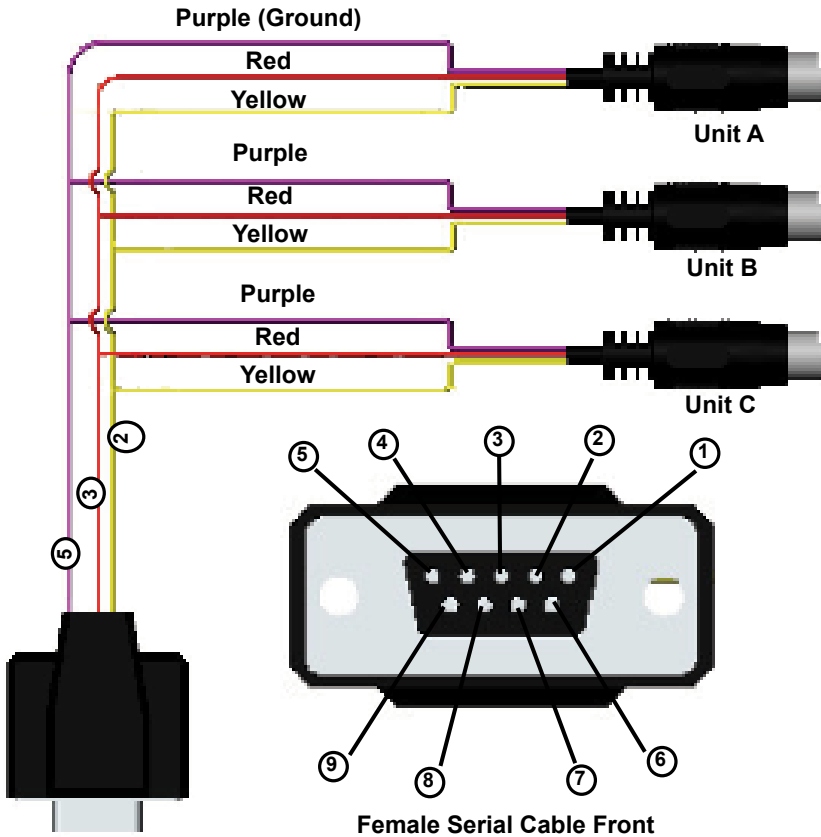

Typical Multiple Device (Addressable) Wiring Configuration



The easiest way to connect multiple devices is with a Multi-Drop Box (see page 54).

Information for Omega TFT (Color Display) Instruments

Omega TFT (color display) instruments have a high contrast back-lit LCD display. TFT instruments operate in accordance with Omega standard operating instructions for our monochrome menus and displays with the following differences.

Multi-Color Display Color Codes:

GREEN: Green labels identify the parameters and/or adjustments associated with the button directly above or below the label.

WHITE: The color of each parameter is displayed in white while operating under normal conditions.

RED: The color of a parameter is displayed in red when operating conditions for that parameter exceed 128% of the device's specifications.

YELLOW: Yellow is the equivalent of the selection arrow on the monochrome display.

LCD Contrast:

LCD contrast is ranged from 0 to 11 on color displays with 11 being the greatest contrast.

Display On/Off:

Pushing the button under the Omega name will turn the device display on or off. This feature is not available on monochrome displays.

Technical Data for TFT (Color Display) Meters, Gauges and Controllers

The following specifications are applicable to Omega **TFT** (color display) meters, gauges and controllers only. All other operating specifications are shown in the Technical Data page for standard Omega instruments. All standard device features and functions are available and operate in accordance with the Omega operating manual provided with the device.

Specification	Meter or Gauge	Small Valve Controller	Large Valve Controller
Supply Voltage	7 to 30 Vdc	12 to 30 Vdc	24 to 30 Vdc
Supply Current	80 mA @ 12Vdc 70 mA @ 24Vdc	290 mA @ 12Vdc 200 mA @ 24Vdc	780 mA @ 24Vdc

DISPLAYS AND MENUS

The device screen defaults to **Main** display as soon as power is applied to the controller.
Note: See page 28 to rotate the display 180°.

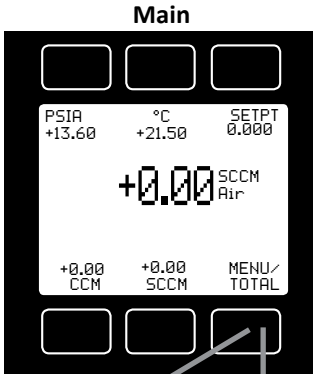

The **Main** display shows pressure, temperature, set-point, volumetric flow and mass flow.

Pressing the button adjacent to a parameter will make that parameter the primary display unit.

By hitting the **MENU** button at the bottom right of the screen you will enter the **Select Menu** display.



If your controller was ordered with the **Totalizer** option (page 52), pushing the **TOTAL** button once will bring up the **Totalizing Mode** display. Pushing **MENU** will bring up the **Select Menu** display.

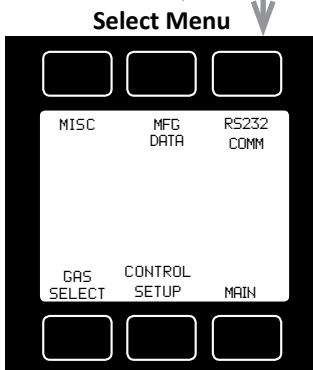

Select Menu

From **Select Menu** you can change the selected gas, interact with your RS232 / RS485 settings, read manufacturer's data or access the control set-up display.

Push **MAIN** to return to the Main display.

MAIN



This mode defaults on power up, with mass flow as the primary displayed parameter.

The following parameters are displayed in the Main mode.

Gas Absolute Pressure: This sensor references hard vacuum and reads incoming pressure both above and below local atmospheric pressure. This parameter is moved to the primary display by pushing the button above **PSIA**.

The engineering unit associated with absolute pressure is pounds per square inch absolute (psia). This can be converted

to gage pressure (psig) by subtracting local atmospheric pressure from the absolute pressure reading:

$$\text{PSIG} = \text{PSIA} - (\text{Local Atmospheric Pressure})$$

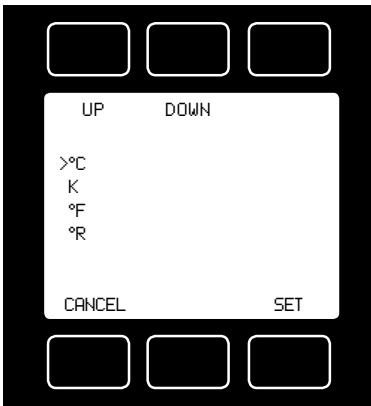

Gas Temperature: FMA-2600A flow controllers measure the incoming temperature of the gas flow. The temperature is displayed in degrees Celsius (°C). This parameter is moved to the primary display by pushing the button above **°C**.

Pushing the button again allows you to select °C (Celsius), K (Kelvin), °F (Fahrenheit) or °R (Rankine) for the temperature scale.

To select a temperature scale, use the UP and DOWN buttons to position the arrow in front of the desired scale.

Press SET to record your selection and return to the MAIN display. The selected

temperature scale will be displayed on the screen.

Set Point: The set-point (**SETPT**) is shown in the upper right of the display.

For information on changing the set-point see SETPT SOURCE, page 18.

Volumetric Flow Rate: This parameter is located in the lower left of the display. It is moved to the primary display by pushing the button below **CCM** in this example. Your display may show a different unit of measure.



WHEN USING A MASS FLOW CONTROLLER AS AN ABSOLUTE PRESSURE CONTROLLER, THE MASS FLOW RATE MAY MOMENTARILY EXCEED THE FLOW MEASUREMENT CAPABILITY (FULL SCALE + 28%) OF THE UNIT. THIS MAY OCCUR WHEN THE UNIT IS ASKED TO MAKE AN ABRUPT PRESSURE CHANGE.

IF THE OPTIONAL TOTALIZER IS IN USE AT THAT TIME, THE TOTALIZED VALUE WILL NECESSARILY BECOME INCORRECT. PLEASE RESET THE TOTALIZER IF SUCH AN 'OVER-FLOW' CONDITION HAS OCCURRED.

Mass Flow Rate: The mass flow rate is the volumetric flow rate corrected to a standard temperature and pressure (typically 14.696 psia and 25 °C).

This parameter is located in the lower middle of the display. It can be moved to the primary display by pushing the button below **SCCM** in this example. Your display may show a different unit of measure preceded by the letter **S**.



To get an accurate volumetric or mass flow rate, the gas being measured must be selected. See Gas Select, page 22.

MENU: Pressing **MENU** switches the screen to the **Select Menu** display.



Flashing Error Message: An error message (**MOV** = mass overrange, **VOV** = volumetric overrange, **POV** = pressure overrange, **TOV** = temperature overrange) flashes when a measured parameter exceeds the range of the sensor. When any item flashes, neither the flashing parameter nor the mass flow measurement is accurate. Reducing the value of the flashing parameter to within specified limits will return the unit to normal operation and accuracy.

If the unit does not return to normal operation contact Omega.

SELECT MENU

From Select Menu you can change the selected gas, interact with your RS232 / RS485 settings, read manufacturer's data and access the control setup screen. Press the button next to the desired operation to bring that function to the screen.

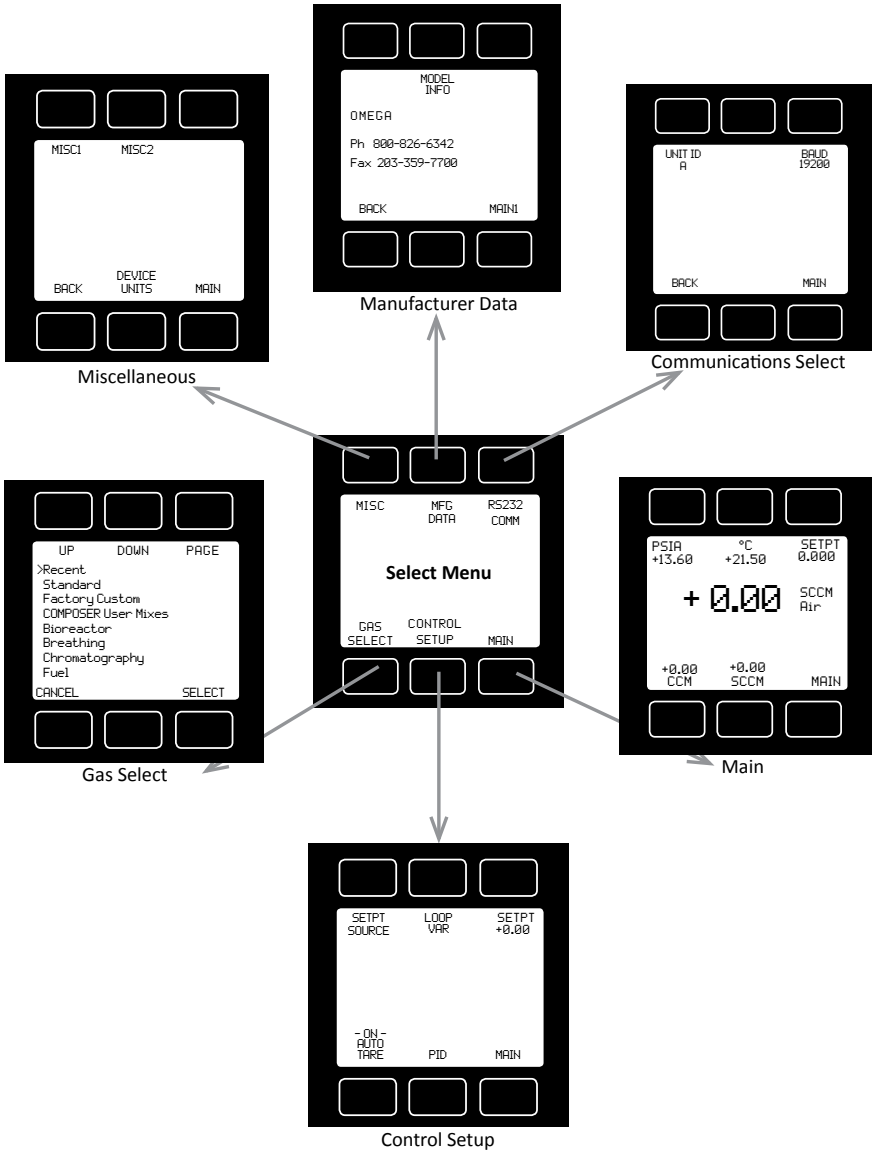

An explanation for each screen can be found on the following pages.

CONTROL SETUP

Control Setup is accessed by pressing the button below Control Setup on the Select Menu display. From this screen you can select your set-point source, choose a loop variable and adjust the PID terms.

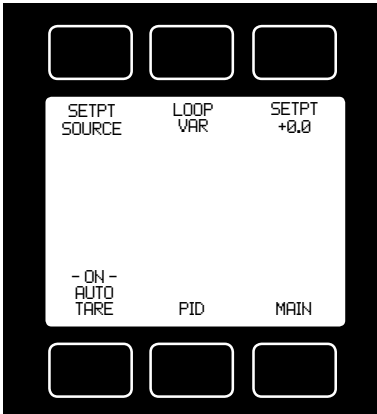

Press BACK to return to the Select Menu display.

Press MAIN to return to the MAIN display

SETPT SOURCE – Pressing the button above SETPT SOURCE will allow you to select how the set point will be conveyed to your controller.

Use the line-up and line-down buttons to move the arrow in front of the desired option. Then press SET.

Press CANCEL to return to the previous display.

The controller will ignore any set-point except that of the selected set-point source and it will remember which input is selected even if the power is disconnected.

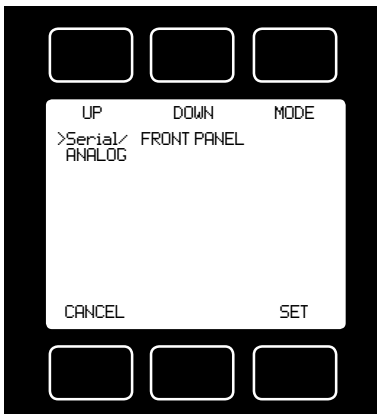

Serial refers to a remote digital RS232 / RS485 set-point applied via a serial connection to a computer or PLC as described in the installation and RS232 / RS485 sections of this manual.

Front Panel refers to a set-point applied directly at the controller.

 **Front Panel input must be selected prior to changing the set-point at the device.**

Analog refers to a remote analog set-point applied to Pin 4 of the Mini-DIN connector as described in the installation

section of this manual. **The standard analog input is 0-5 Vdc.**

 **To determine what type of analog set-point your controller has, refer to the Calibration Data Sheet that was included with your controller.**

If nothing is connected to Pin 4, and the controller is set for analog control, the device will generate random set-point values.

NOTE: If your controller has the IPC (Integrated Potentiometer Control) option, the IPC dial will operate with the ANALOG set-point source selected.

SETPT refers to the **set-point**. This parameter may be changed using the display only if **FRONT PANEL** is selected as the Input. Press **SETPT**. Then use SELECT to choose the decimal with the arrow and the UP and DOWN buttons to change the value. Press SET to record your value. Press CLEAR to return to zero.



CAUTION! NEVER LEAVE A CONTROLLER WITH A NON-ZERO SET-POINT IF NO PRESSURE IS AVAILABLE TO MAKE FLOW. THE CONTROLLER WILL APPLY FULL POWER TO THE VALVE IN AN ATTEMPT TO REACH THE SET-POINT. WHEN THERE IS NO FLOW, THIS CAN MAKE THE VALVE VERY HOT!

CONTROL SETUP (continued)

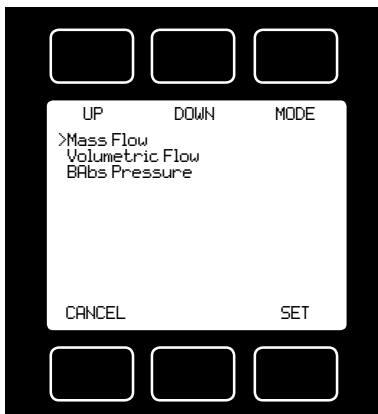
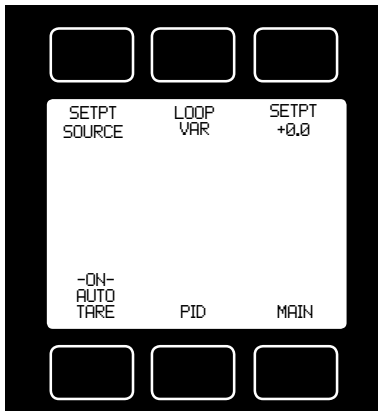

LOOP VAR—The selection of what variable to close the loop on is a feature unique to FMA-2600A mass flow controllers.

Pressing the **LOOP VAR** button on the Control Setup screen will allow you to change what variable is controlled.

Use the line-up and line-down buttons to move the arrow in front of the desired option.

When the mass flow controller is supplied with the **control valve upstream** of the electronics portion of the system, the unit can be set to control on outlet pressure (absolute pressures only) or volumetric flow rate, instead of mass flow rate.

The change from mass to volume can usually be accomplished without much, if any, change in the P and D settings.



When you change from controlling flow to controlling pressure, sometimes fairly radical changes must be made to the P & D variables. See page 20 – PID TUNING.

Contact Omega if you are having difficulties with this procedure.

ON AUTO / OFF AUTO—refers to the standard auto-tare or “auto-zero” feature.

The auto-tare feature automatically tares (takes the detected signal as zero) the unit when it receives a zero set-point for more than two seconds.

A zero set-point results in the closing of the valve and a known “no flow” condition. This feature makes the device more accurate by periodically removing any cumulative errors associated with drift.



It is recommended that the controller be left in the default auto-tare ON mode unless your specific application requires that it be turned off.

PID TUNING

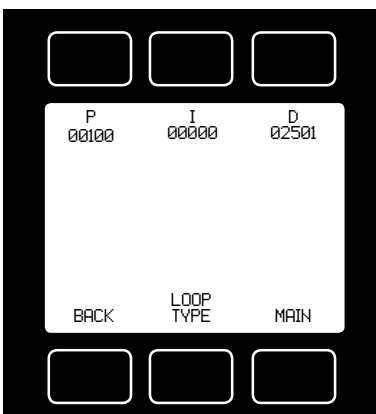
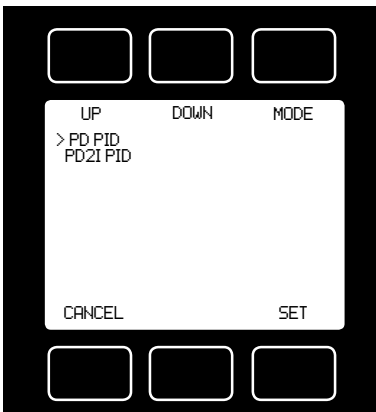
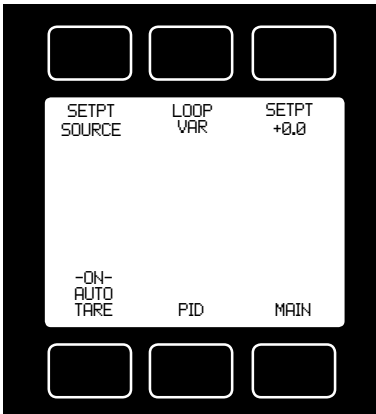

PID Values determine the performance and operation of your proportional control valve. These terms dictate control speed, control stability, overshoot and oscillation. All units leave the factory with a generic tuning designed to handle most applications. If you encounter issues with valve stability, oscillation or speed, fine tuning these parameters may resolve the problem.

FMA-2600A controllers allow you to adjust the Proportional, Integral and Differential terms of the PID control loop.

To change the PID loop parameters, push the button below **PID**.

Press **LOOP TYPE**. Then use the LN-UP and LN-DN buttons to select the appropriate PID control algorithm. Press SET.

See the following page for descriptions of the PID Loop Types (PID Control Algorithms).

P refers to the Proportional term of the PID loop.

I refers to the Integral term of the PID loop.

D refers to the Differential term of the PID loop.

Press P, I or D. Then use SELECT to choose the decimal with the arrow and the UP and DOWN buttons to change the value. Press SET to record your value. Press CLEAR to return to zero.



Before changing the P, I or D parameter, please record the initial value so that it can be returned to the factory setting if necessary.

Valve tuning can be complex. If you would like assistance, please contact Omega for technical support.

The PD algorithm is the PID algorithm used on most FMA-2600A controllers.

It is divided into two segments:

The first compares the process value to the set-point to generate a proportional error. The proportional error is multiplied by the 'P' gain, with the result added to the output drive register.

The second operates on the present process value minus the process value during the immediately previous evaluation cycle. This 'velocity' term is multiplied by the 'D' gain, with the result subtracted from the output drive register.

The above additions to and subtractions from the output drive register are carried over from process cycle to process cycle, thus performing the integration function automatically.

Increasing the 'P' gain will **promote** the tendency of the system to overshoot, ring, or oscillate.

Increasing the 'D' gain will **reduce** the tendency of the system to overshoot.

The PD21 algorithm is a PID algorithm used primarily for high performance pressure and flow control applications.

It exhibits two basic differences from the PD algorithm that most controllers utilize.

1. Instead of applying a damping function based upon the rate of change of the process value, it applies a damping function based upon the square of the rate of change of the process value.
2. The damping function is applied directly to the proportional error term before that term is used in the proportional and integral functions of the algorithm. This provides a certain amount of 'look ahead' capability in the control loop.

Because of these differences, you will note the following:

1. Increasing 'P' gain can be used to damp out overshoot and slow oscillations in pressure controllers. You will know that 'P' gain is too high, when the controller breaks into fast oscillations on step changes in set-point. On flow controllers, too high a 'P' gain results in slower response times. Too low a 'P' gain results in overshoot and/or slow oscillation. A good starting value for 'P' gain is 200.
2. If the unit was originally shipped with the PD21 algorithm selected, the 'D' gain value should be left at or near the factory setting because it relates primarily to the system phase lags. If you are changing from the default algorithm to the PD21 algorithm, you should start with a 'D' gain value of 20.
3. The 'I' gain is used to control the rate at which the process converges to the set-point, after the initial step change. Too low a value for 'I' gain shows up as a process value that jumps to near the set-point and then takes awhile to converge the rest of the way. Too high a value for 'I' gain results in oscillation. A good starting value for the 'I' gain is 200.

GAS SELECT

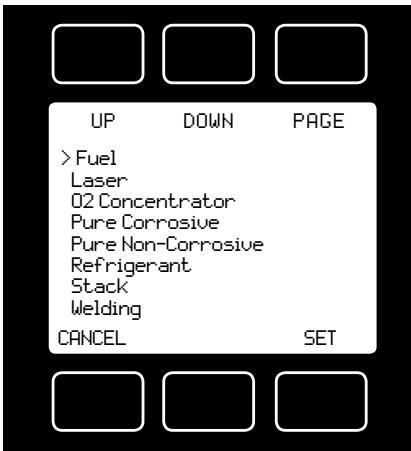
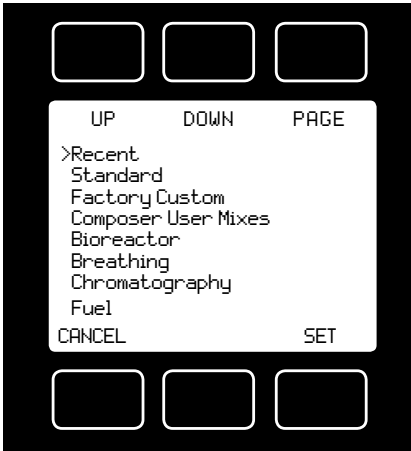

Gas Select allows you to set your device to up to 150 standard gases and mixes. You can also use **composer** to program and store up to 20 additional gas mixes.

Gas Select is accessed by pressing the button below **GAS SELECT** on the Select Menu display.

To select a gas, use the UP and DOWN buttons to position the arrow in front of the desired gas category.

- » Recent: Eight most recent selections
- » Standard: Gases and mixes standard on earlier Omega instruments (page 37)
- » Factory Custom: Present only if customer requested gases were added at the factory
- » Composer User Mixes: Gas mixes programmed by the user (page 23)
- » Bioreactor (page 43)
- » Breathing (page 44)
- » Chromatography (page 46)
- » Fuel (page 45)
- » Laser (page 45)
- » O2 Concentrator (page 46)
- » Pure Corrosive* (page 40)
- » Pure Non-Corrosive (page 39)
- » Refrigerant* (page 41)
- » Stack (page 46)
- » Welding (page 42)

Press PAGE to view a new page in the gas category list.

Press SELECT to view the gases in the selected category. Align the arrow with the desired gas. Press SET to record your selection and return to the MAIN display. The selected gas will be displayed on the screen.

* Pure Corrosive and Refrigerant gases are only available on **FMA-2600A-LSS Series** instruments that are compatible with these gases.

Note: Gas Select may not be available on units ordered with a custom gas or blend.

See pages 39 -46 for a full list of gases in each category.

COMPOSER

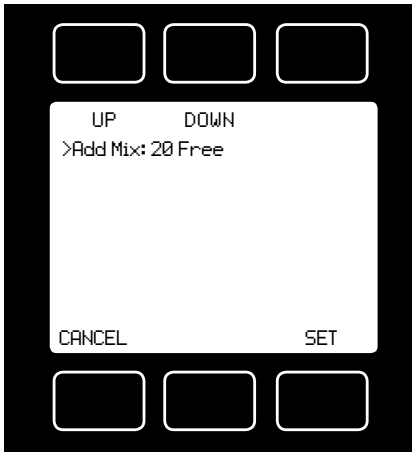

Composer allows you to program and save up to 20 custom gas mixes containing 2 to 5 component gases found in the gas lists (pages 39-46). The minimum resolution is 0.01%.

Composer is accessed by selecting **Composer User Mixes** on the GAS SELECT display.

Press SET when the arrow is aligned with Add Mix.

Name the mix by pressing the UP and DOWN buttons for letters, numerals and symbols.

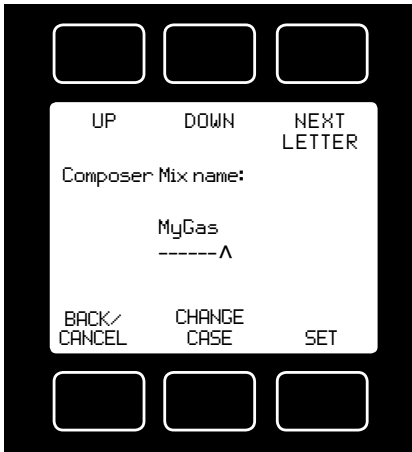

CHANGE CASE – Toggles the letter case. Letters remain in selected case until CHANGE CASE is pushed again.

Press SET to save the name.

After naming the mix, press **ADD GAS** and select the gas category and the component gas.

Select the digit with arrow and adjust the % with the UP and DOWN buttons. Press set to save. Add up to 4 more gases as needed. The total must equal 100% or an error message will appear.

GAS OPTNS allows you to adjust the percentage of the constituents or delete a gas from the mix. Gas mixes cannot be adjusted after they have been saved.

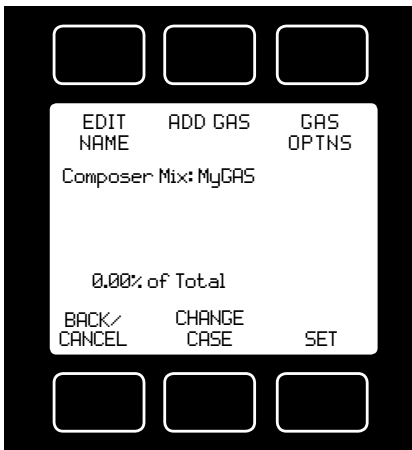

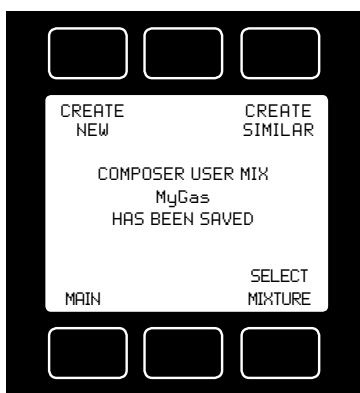
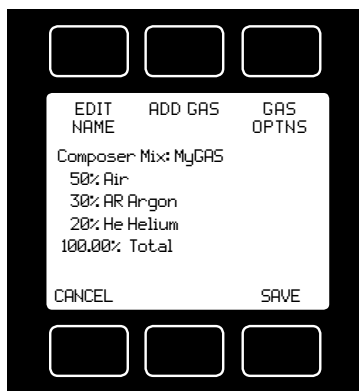
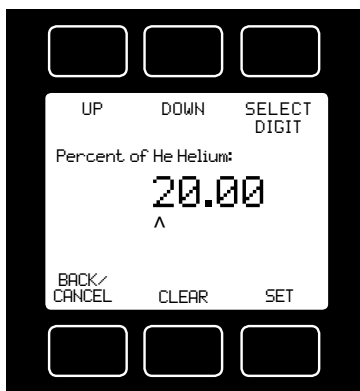
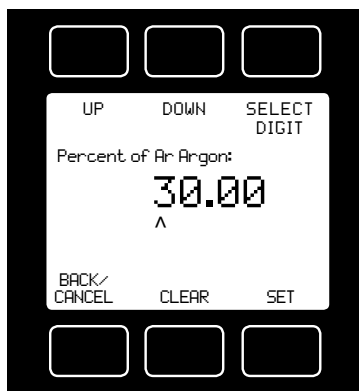
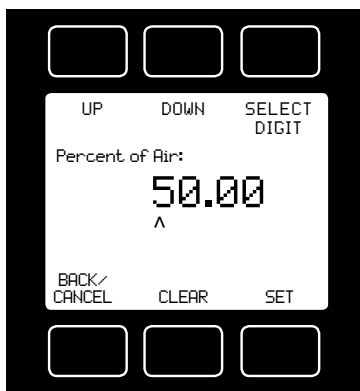

Once the mix has been saved, you may press **CREATE SIMILAR** to compose an additional mix based on the mix you have just saved. This CREATE SIMILAR option is not available after leaving this screen.

Press **CREATE NEW** to add a completely new mix.

Press **SELECT MIXTURE** to bring the custom mix onto the MAIN display.

COMMUNICATION SELECT

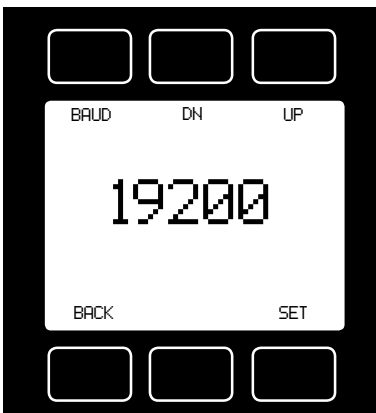
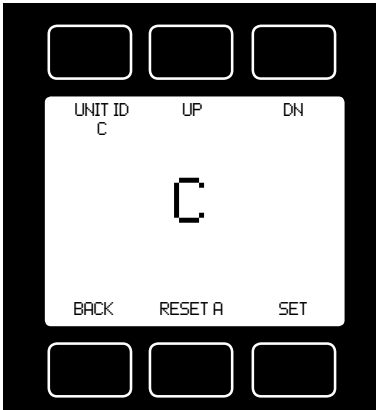
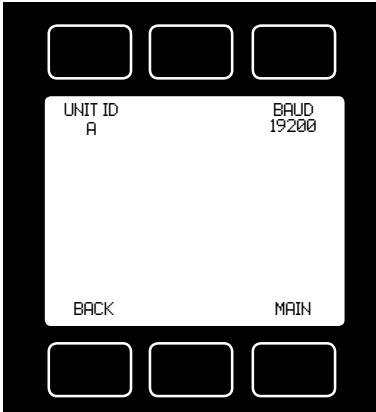

Access **Communication Select** by pressing the button above **RS232 COMM** or **RS485 COMM** on the **Select Menu** display.

Unit ID – Valid unit identifiers are the letters A-Z and @. The identifier allows you to assign a unique address to each device so that multiple units can be connected to a single RS232 or RS485 computer port.

Press **UNIT ID**. Use the UP and DOWN buttons to change the Unit ID. Press SET to record the ID. Press Reset to return to the previously recorded Unit ID.

Any Unit ID change will take effect when Communication Select is exited.

If the symbol @ is selected as the Unit ID, the device will enter streaming mode when Communication Select is exited. See RS232 Communications (page 31) for information about the streaming mode.

Baud – Both this instrument and your computer must send/receive data at the same baud rate. The default baud rate for this device is 19200 baud.

Press **BAUD**. Use the UP and DOWN buttons to select the baud rate that matches your computer. The choices are 38400, 19200, 9600, or 2400 baud. Press SET to record the baud rate.

Any baud rate change will not take effect until power to the unit is cycled.

MISCELLANEOUS

Miscellaneous is accessed by pressing the **MISC** button on the Select Menu display. Next select either **MISC1** or **MISC2**.

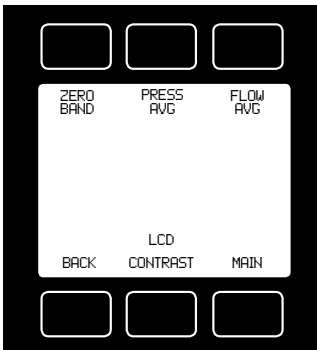

MISC1 will display as shown at left.

ZERO BAND refers to Display Zero Deadband.

Zero deadband is a value below which the display jumps to zero. This deadband is often desired to prevent electrical noise from showing up on the display as minor flows or pressures that do not exist. Display Zero Deadband does not affect the analog or digital signal outputs.

ZERO BAND can be adjusted between 0 and 6.3% of the sensor's Full Scale (FS).

Press **ZERO BAND**. Then use SELECT to choose the digit with the arrow and the UP and DOWN buttons to change the value. Press SET to record your value. Press CLEAR to return to zero.

Pressure Averaging and Flow Averaging may be useful to make it easier to read and interpret rapidly fluctuating pressures and flows. Pressure and flow averaging can be adjusted between 1 (no averaging) and 256 (maximum averaging).

These are geometric running averages where the number between 1 and 256 can be considered roughly equivalent to the response time constant in milliseconds.

This can be effective at "smoothing" high frequency process oscillations such as those caused by diaphragm pumps.

Press **PRESS AVG**. Then use SELECT to choose the digit with the arrow and the UP and DOWN buttons to change the value. Press SET to record your value. Press CLEAR to return to zero.

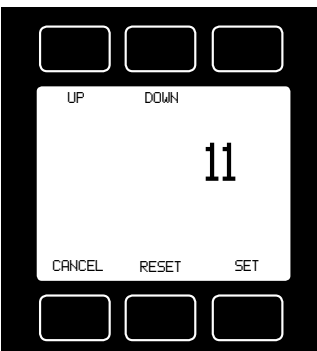

Press **FLOW AVG**. Then use SELECT to choose the digit with the arrow and the UP and DOWN buttons to change the value. Press SET to record your value. Press CLEAR to return to zero.

Setting a higher number will equal a smoother display.

LCD CONTRAST: The display contrast can be adjusted between 0 and 31, with zero being the lightest and 31 being the darkest. Use the UP and DOWN buttons to adjust the contrast. Press SET when you are satisfied. Press CANCEL to return to the MISC display.

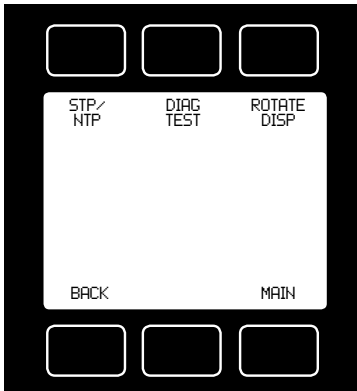

MISC2 will display as shown at left.

STP/NPT refers to the functions that allow your selection of *standard* temperature and pressure conditions or *normal* temperature and pressure conditions. This feature is generally useful for comparison purposes to other devices or systems using different STP parameters.

The **STP** menu is comprised of the **STP TEMP** and **STP PRESS** screens.

STP TEMP allows you to select from °C, °F, K or °R. The arrow position will automatically default to the currently stored value.

The **NTP** menu is comprised of the **NTP TEMP** and **NTP PRESS** screens.

Once a selection has been made and recorded using the **SET** button, a change acknowledgement message will be displayed on screen.

Selecting **MAIN** will revert screen to the Main display. If the **SET** selection is already the currently stored value, a message indicating that fact will appear.

STP PRESS enables you to select from a menu pressure settings. Use the UP/DOWN or PAGE buttons to view the settings.

The arrow position will automatically default to the currently stored value.

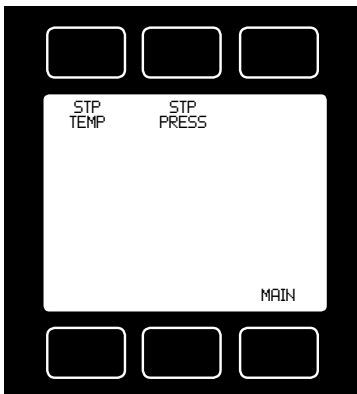

Once a selection has been made and recorded using the **SET** button, a change acknowledgement message will be displayed on screen.

Pressing **SET** again will revert screen to the Main display. If the **SET** selection is already the currently stored value, a message indicating that fact will appear.

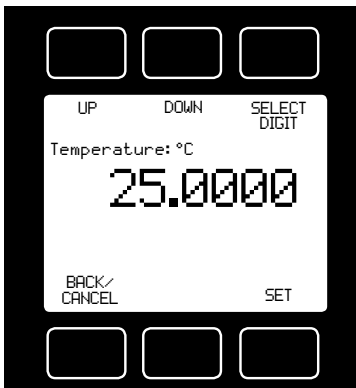

STP TEMP Display

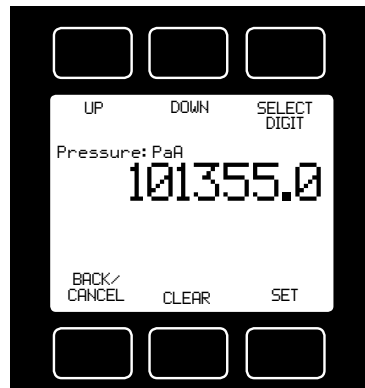

STP PRESS Display



DIAG TEST: This diagnostic screen displays the current internal register values, which is useful for noting factory settings prior to making any changes. It is also helpful for troubleshooting with Omega customer service personnel.

Select the **DIAG TEST** button from the **MISC** screen to view a list of select register values. Pressing the **SCROLL** button will cycle the display through the register screens. An example screen is shown at left.

Press **ROTATE DISP** and **SET** to **Inverted 180°** if your device is inverted. The display and buttons will rotate together.

DEVICE UNITS

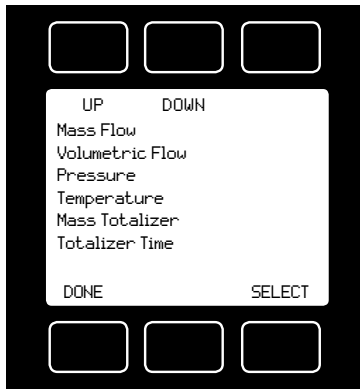

Press **DEVICE UNITS** to access menus of units of measure for each parameter (and totalizer if so equipped).

Scroll to the desired unit and press select. Once selected, you will see the message shown below. Verify that all connected devices expect the change.

See pages 47 and 48 for a full list of available units.

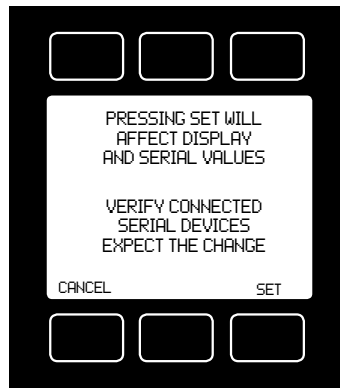
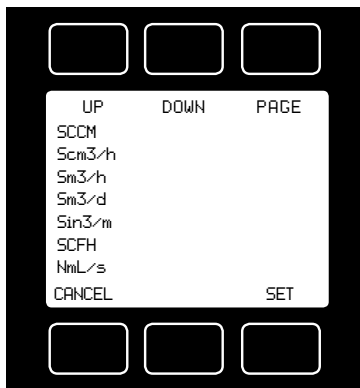

MANUFACTURER DATA



Manufacturer Data is accessed by pressing the **MFG DATA** button on the Select Menu display.

The initial display shows the name and telephone number of the manufacturer.

Press **MODEL INFO** to show important information about your flow meter including the model number, serial number, and date of manufacture.

Press **BACK** to return to the MFG DATA display.

Push **MAIN** to return to the Main display.

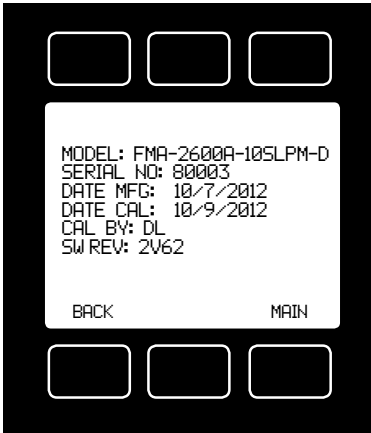

FMA-2600A-P Controller Operating Notes

The FMA-2600A-P mass flow controller is equipped with an integrated Swagelok® positive shutoff valve.

The normally closed valve is air actuated and will remain closed until it is connected to an air source supplying between 60 and 120 psig of air pressure. Once the appropriate amount of air pressure is supplied to the shutoff valve, it will open, allowing flow through the mass controller. Air pressure must be removed from the shutoff valve in order for the valve to close.

A common method for actuating the shutoff valve incorporates a three-way solenoid valve (below).

Air pressure is applied to one side of the solenoid valve while the other side of the solenoid is left open to atmosphere.

When the solenoid is energized, air pressure is delivered to the shutoff valve, allowing it to open.

When the solenoid is returned to a relaxed state, air pressure is removed from the shutoff valve, allowing it to close. The air pressure is vented to atmosphere.

Note: All standard FMA-2600A device features and functions are available on the FMA-2600A-P controllers and operate in accordance with the standard FMA-2600A operating instructions.

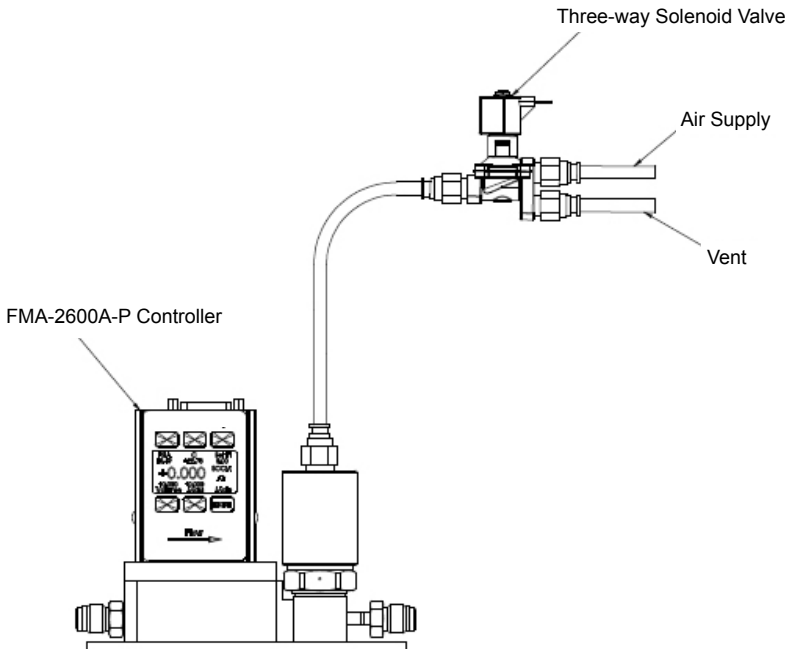

FMA-2600A-P controller and three-way solenoid valve.

RS232 / RS485 Output and Input

Configuring HyperTerminal®:

1. Open your HyperTerminal® RS232 / RS485 terminal program (installed under the “Accessories” menu on all Microsoft Windows® operating systems).
2. Select “Properties” from the file menu.
3. Click on the “Configure” button under the “Connect To” tab. Be sure the program is set for: 19,200 baud (or matches the baud rate selected in the RS232 / RS485 communications menu on the meter) and an 8-N-1-None (8 Data Bits, No Parity, 1 Stop Bit, and no Flow Control) protocol.
4. Under the “Settings” tab, make sure the Terminal Emulation is set to ANSI or Auto Detect.
5. Click on the “ASCII Setup” button and be sure the “Send Line Ends with Line Feeds” box is not checked and the “Echo Typed Characters Locally” box and the “Append Line Feeds to Incoming Lines” boxes are checked. Those settings not mentioned here are normally okay in the default position.
6. Save the settings, close HyperTerminal® and reopen it.

Streaming Mode (RS485 units do not have a streaming mode)

In the **default** Polling Mode, the screen should be blank except the blinking cursor. In order to get the data streaming to the screen, hit the “Enter” key several times to clear any extraneous information. Type “* @=@” followed by “Enter” (or using the RS232 / RS485 communication select menu, select @ as identifier and exit the screen). If data still does not appear, check all the connections and COM port assignments.

Streaming Mode – Advanced

The streaming data rate is controlled by register 91. The recommended default rate of data provision is once every 50 milliseconds and this is suitable for most purposes. If a slower or faster streaming data rate is desired, register 91 can be changed to a value from 1 millisecond to 65535 milliseconds, or slightly over once every minute. Below approximately 40 milliseconds, data provision will be dependent upon how many parameters are selected. Fewer data parameters can be streamed more quickly than more. It is left to the user to balance streaming speed with number of parameters streamed.

To read register 91, type “*r91” followed by “Enter”.

To modify register 91, type “*w91=X”, where X is a positive integer from 1 to 65535, followed by “Enter”.

To return to the recommended factory default streaming speed, type “*w91= 50”.

Changing From Streaming to Polling Mode:

When the meter is in the Streaming Mode (*RS485 units do not have a streaming mode*), the screen is updated approximately 10-60 times per second (depending on the amount of data on each line) so that the user sees the data essentially in real time. It is sometimes desirable, and necessary when using more than one unit on a single RS232 line, to be able to poll the unit.

In Polling Mode the unit measures the flow normally, but only sends a line of data

when it is “polled”. Each unit can be given its own unique identifier or address. Unless otherwise specified each unit is shipped with a default address of capital A. Other valid addresses are B thru Z.

Once you have established communication with the unit and have a stream of information filling your screen:

1. Type `*@=A` followed by “Enter” (or using the RS232 / RS485 communication select menu, select A as identifier and exit the screen) to stop the streaming mode of information. Note that the flow of information will not stop while you are typing and you will not be able to read what you have typed. Also, the unit does not accept a backspace or delete in the line so it must be typed correctly. If in doubt, simply hit enter and start again. If the unit does not get exactly what it is expecting, it will ignore it. If the line has been typed correctly, the data will stop.
2. You may now poll the unit by typing A followed by “Enter”. This does an instantaneous poll of unit A and returns the values once. You may type A “Enter” as many times as you like. Alternately you could resume streaming mode by typing `*@=@` followed by “Enter”. Repeat step 1 to remove the unit from the streaming mode.
3. To assign the unit a new address, type `*@=New Address`, e.g. `*@=B`. Care should be taken not to assign an address to a unit if more than one unit is on the RS232 / RS485 line as all of the addresses will be reassigned. Instead, each should be individually attached to the RS232 / RS485 line, given an address, and taken off. After each unit has been given a unique address, they can all be put back on the same line and polled individually.

Sending a Set-point via RS232 / RS485: To send a set-point via RS232 / RS485, “Serial” must be selected under the “Input” list in the control set up mode.

Method 1: Set-point may be set in floating point in serial communication using serial command (UnitID)SX.YZ

Example: AS4.54 results in Unit ID A changing set-point to 4.54.

Method 2: Type in a number between 0 and 65535 (2% over range), where 64000 denotes full-scale flow rate, and hit “Enter”.

The set-point column and flow rates should change accordingly. If they do not, try hitting “Enter” a couple of times and repeating your command. The formula for performing a linear interpolation is as follows:

$$\text{Value} = (\text{Desired Set-point} \times 64000) / \text{Full Scale Flow Range}$$

For example, if your device is a 100 slpm full-scale unit and you wish to apply a set-point of 35 slpm you would enter the following value:

$$22400 = (35 \text{ slpm} \times 64000) / 100 \text{ slpm}$$

If the controller is in polling mode as described in *Changing from Streaming Mode to Polling Mode*, the set-point must be preceded by the address of the controller. For example, if your controller has been given an address of D, the set-point above would be sent by typing:

D22400 followed by “Enter”

To adjust the Proportional and Differential (P&D) terms via RS232 / RS485:

Type *@=A followed by “Enter” to stop the streaming mode of information.

To adjust the “P” or proportional term of the PID controller, type *R21 followed by “Enter”.

The computer will respond by reading the current value for register 21 between 0-65535. It is good practice to write this value down so you can return to the factory settings if necessary. Enter the value you wish to try by writing the new value to register 21. For example, if you wished to try a “P” term of 220, you would type *W21=**220** followed by “Enter” where the bold number denotes the new value.

The computer will respond to the new value by confirming that 21=220. To see the effect of the change you may now poll the unit by typing A followed by “Enter”. This does an instantaneous poll and returns the values once. You may type A “Enter” as many times as you like. Alternately you could resume streaming mode by typing *@=@ followed by “Enter”. Repeat step 3 to remove the unit from the streaming mode.

To adjust the “D” or proportional term of the PID controller, type *R22 followed by “Enter”.

The computer will respond by reading the current value for register 22 between 0-65535. It is good practice to write this value down so you can return to the factory settings if necessary. Enter the value you wish to try by writing the new value to register 22. For example, if you wished to try a “D” term of 25, you would type *W22=**25** followed by “Enter” where the bold number denotes the new value.

The computer will respond to the new value by confirming that 22=25. To see the effect of the change you may now poll the unit by typing A followed by “Enter”. This does an instantaneous poll and returns the values once. You may type A “Enter” as many times as you like. Alternately you could resume streaming mode by typing *@=@ followed by “Enter”. Repeat.

You may test your settings for a step change by changing the set-point. To do this type A32000 (A is the default single unit address, if you have multiple addressed units on your RS232 / RS485 line the letter preceding the value would change accordingly.) followed by “Enter” to give the unit a ½ full scale set-point. Monitor the unit’s response to the step change to ensure it is satisfactory for your needs. Recall that the “P” term controls how quickly the unit goes from one set-point to the next, and the “D” term controls how quickly the signal begins to “decelerate” as it approaches the new set-point (controls the overshoot).

Gas Select – The selected gas can be changed via RS232 / RS485 input. To change the selected gas, enter the following commands:

In Polling Mode: Address\$\$#<Enter> (e.g. B\$\$#<Enter>)

Where # is the number of the gas selected from the table below. Note that this also corresponds to the gas select menu on the flow controller screen:

#	GAS	
0	Air	Air
1	Argon	Ar
2	Methane	CH4
3	Carbon Monoxide	CO
4	Carbon Dioxide	CO2
5	Ethane	C2H6
6	Hydrogen	H2
7	Helium	He
8	Nitrogen	N2
9	Nitrous Oxide	N2O
10	Neon	Ne
11	Oxygen	O2
12	Propane	C3H8
13	normal-Butane	n-C4H10
14	Acetylene	C2H2
15	Ethylene	C2H4
16	iso-Butane	i-C2H10
17	Krypton	Kr
18	Xenon	Xe
19	Sulfur Hexafluoride	SF6
20	75% Argon / 25% CO2	C-25
21	90% Argon / 10% CO2	C-10
22	92% Argon / 8% CO2	C-8
23	98% Argon / 2% CO2	C-2
24	75% CO2 / 25% Argon	C-75
25	75% Argon / 25% Helium	A-75
26	75% Helium / 25% Argon	A-25
27	90% Helium / 7.5% Argon / 2.5% CO2 (Praxair - Helistar® A1025)	A1025
28	90% Argon / 8% CO2 / 2% Oxygen (Praxair - Stargon® CS)	Star29
29	95% Argon / 5% Methane	P-5

For example, to select Propane, enter: \$\$12<Enter>

Creating and Deleting Gas Mixtures with Composer using RS232 or RS485

Note: All commands must be prefixed with the unit ID letter. The unit should not be in streaming mode.

You may create and store up to 20 gas mixtures containing up to five constituent gases each. The constituent gases must be chosen from the existing list of gases installed on the device (which may vary model to model). Please see pages 39 – 46 for lists of gases and their corresponding gas numbers.

Create a Gas Mixture

To create a gas mixture, enter a single-line command according to the following formula:
[Unit ID] GM [Gas Name] [Gas Mix Number] [Percent 1] [Gas Number 1]
[Percent 2] [Gas Number 2] ...etc. etc.

Notes: Do not type the brackets. There should be only one space between all items. Any percentages less than 1, should have a leading zero before the decimal (i.e. 0.25 for .25%). Trailing zeros are not necessary but they are allowed to help visualize the percentages on screen (as in the example). The sum of all percentages must be 100.00 otherwise an error will occur.

Here is an example of a three gas mixture for a new gas called “MyMix1” (50% O₂, 49.5% Helium, and .5% Neon), stored in user location #236, where the unit ID of the device is “A”:

A GM MyMix1 236 50.00 11 49.50 7 0.50 10 <ENTER>

Gas Name: Name your mixture using a maximum of 6 characters.

Gas Mix Number: Composer user mixes have Omega gas numbers between 236 and 255. You can assign any number in this range to your new mixture. If another mixture with the same number exists, it will be overwritten, even if that gas is currently selected on the unit. If you enter a 0 here, the new mix will be assigned the next available number between 236 and 255.

Percent 1: The percentage of the first constituent gas. The percentage of each constituent must be between 0.01 and 99.99. Values entered beyond two decimal points will be rounded to the nearest 0.01%.

Gas Number 1: The Omega gas number of the first constituent gas.

Percent 2: The percentage of the second constituent gas. Values entered beyond two decimal points will be rounded to the nearest 0.01%.

Gas Number 2: The Omega gas number of the second constituent gas.

Additional Gases: (Optional) The above pattern of [Percent] + [Gas Number] may be repeated for additional constituent gases (up to a total of five).

Upon success, the unit ID (if set) is returned followed by a space. The number of the gas mixture is then returned, followed by the percentages and names of each constituent in the mix. If the gas mix is not successfully created, a “?” is returned, and you must start over.

Delete a Gas Mixture

To delete a gas mixture, enter:

[Unit ID]GD [Gas Number]: The number of the Composer user mixture you wish to delete from the unit

Only Composer user mixtures can be deleted with this command.

On success, the unit ID (if set) is returned followed by a space and the number of the gas deleted. If the gas is not successfully deleted, a “?” is returned.

Collecting Data:

The RS232/RS485 output updates to the screen many times per second. Very short-term events can be captured simply by disconnecting (there are two telephone symbol icons at the top of the HyperTerminal® screen for disconnecting and connecting) immediately after the event in question. The scroll bar can be driven up to the event and all of the data associated with the event can be selected, copied, and pasted into Microsoft® Excel® or other spreadsheet program as described below.

For longer term data, it is useful to capture the data in a text file. With the desired data streaming to the screen, select “Capture Text” from the Transfer Menu. Type in the path and file name you wish to use. Push the start button. When the data collection period is complete, simply select “Capture Text” from the Transfer Menu and select “Stop” from the sub-menu that appears.

Data that is selected and copied, either directly from HyperTerminal® or from a text file can be pasted directly into Excel®. When the data is pasted it will all be in the selected column. Select “Text to Columns...” under the Data menu in Excel® and a Text to Columns Wizard (dialog box) will appear.

Make sure that “Fixed Width” is selected under Original Data Type in the first dialog box and click “Next”. In the second dialog box, set the column widths as desired, but the default is usually acceptable. Click on “Next” again. In the third dialog box, make sure the column data format is set to “General”, and click “Finish”. This separates the data into columns for manipulation and removes symbols such as the plus signs from the numbers. Once the data is in this format, it can be graphed or manipulated as desired. ***For extended term data capture see page 37.***

Data Format:

The data stream on the screen represents the flow parameters of the main mode in the units shown on the display.

For mass flow controllers, there are six columns of data representing pressure, temperature, volumetric flow, mass flow, set-point, and the selected gas

The first column is absolute pressure (normally in psia), the second column is temperature (normally in °C), the third column is volumetric flow rate (in the units specified at time of order and shown on the display), the fourth column is mass flow (also in the units specified at time of order and shown on the display), the fifth column is the currently selected set-point value, the sixth column designates the currently selected gas. For instance, if the controller was ordered in units of scfm, the display on the controller would read 2.004 scfm and the last two columns of the output below would represent volumetric flow and mass flow in cfm and scfm respectively.

+014.70	+025.00	+02.004	+02.004	2.004	Air
+014.70	+025.00	+02.004	+02.004	2.004	Air
+014.70	+025.00	+02.004	+02.004	2.004	Air
+014.70	+025.00	+02.004	+02.004	2.004	Air
Pressure	Temp	Vol. Flow	Mass Flow	Set Point	Gas

FMA-2600A Mass Flow Controller Data Format

Note: On units with the totalizer function, the sixth column will be the totalizer value, with gas select moving to a seventh column.

Sending a Simple Script File to HyperTerminal®

It is sometimes desirable to capture data for an extended period of time. Standard streaming mode information is useful for short term events, however, when capturing data for an extended period of time, the amount of data and thus the file size can become too large very quickly. Without any special programming skills, the user can use HyperTerminal® and a text editing program such as Microsoft® Word® to capture text at user defined intervals.

1. Open your text editing program, MS Word for example.
2. Set the cap lock on so that you are typing in capital letters.
3. Beginning at the top of the page, type A<Enter> repeatedly. If you're using MS Word, you can tell how many lines you have by the line count at the bottom of the screen. The number of lines will correspond to the total number of times the flow device will be polled, and thus the total number of lines of data it will produce.

For example: A
 A
 A
 A
 A
 A
 A

will get a total of six lines of data from the flow meter, but you can enter as many as you like.

The time between each line will be set in HyperTerminal.

4. When you have as many lines as you wish, go to the File menu and select save. In the save dialog box, enter a path and file name as desired and in the "Save as Type" box, select the plain text (.txt) option. It is important that it be saved as a generic text file for HyperTerminal to work with it.
5. Click Save.
6. A file conversion box will appear. In the "End Lines With" drop down box, select CR Only. Everything else can be left as default.
7. Click O.K.
8. You have now created a "script" file to send to HyperTerminal. Close the file and exit the text editing program.
9. Open HyperTerminal and establish communication with your flow device as outlined in the manual.
10. Set the flow device to Polling Mode as described in the manual. Each time you type A<Enter>, the meter should return one line of data to the screen.
11. Go to the File menu in HyperTerminal and select "Properties".
12. Select the "Settings" tab.
13. Click on the "ASCII Setup" button.
14. The "Line Delay" box is defaulted to 0 milliseconds. This is where you will tell the program how often to read a line from the script file you've created. 1000 milliseconds is one second, so if you want a line of data every 30 seconds, you

would enter 30000 into the box. If you want a line every 5 minutes, you would enter 300000 into the box.

15. When you have entered the value you want, click on OK and OK in the Properties dialog box.

16. Go to the Transfer menu and select "Send **Text** File..." (NOT Send File...).

17. Browse and select the text "script" file you created.

18. Click Open.

19. The program will begin "executing" your script file, reading one line at a time with the line delay you specified and the flow device will respond by sending one line of data for each poll it receives, when it receives it.

You can also capture the data to another file as described in the manual under "Collecting Data". You will be simultaneously sending it a script file and capturing the output to a separate file for analysis.

Operating Principle

All FMA-1600A Gas Flow Meters and FMA-2600A Gas Flow Controllers are based on the accurate measurement of volumetric flow. The volumetric flow rate is determined by creating a pressure drop across a unique internal restriction, known as a Laminar Flow Element (LFE), and measuring differential pressure across it. The restriction is designed so that the gas molecules are forced to move in parallel paths along the entire length of the passage; hence laminar (streamline) flow is established for the entire range of operation of the device. Unlike other flow measuring devices, in laminar flow meters the relationship between pressure drop and flow is linear.

STANDARD GAS DATA TABLES: Those of you who have older FMA-2600A products may notice small discrepancies between the gas property tables of your old and new units. Omega has incorporated the latest data sets from NIST (including their REFPROP 9 data where available) in our products' built-in gas property models. Be aware that the calibrators that you may be using may be checking against older data sets such as the widely distributed Air Liquide data. This may generate apparent calibration discrepancies of up to 0.6% of reading on well behaved gases and as much as 3% of reading on some gases such as propane and butane, unless the standard was directly calibrated on the gas in question.

As the older standards are phased out, this difference in readings will cease to be a problem. If you see a difference between the Omega meter and your in-house standard, in addition to calling Omega at, call the manufacturer of your standard for clarification as to which data set they used in their calibration. This comparison will in all likelihood resolve the problem.

GAS SELECT > Standard:

FMA-2600A Controllers will display: Acetylene, Air, Argon, Butane, Carbon Dioxide, Carbon Monoxide, Ethane, Ethylene (Ethene), Helium, Hydrogen, Iso-Butane, Krypton, Methane, Neon, Nitrogen, Nitrous Oxide, Oxygen, Propane, Sulfur Hexafluoride, Xenon, HE-25, HE-75, A1025, C-2, C-8, C-10, C-25, C-75, P-5, Star29.

FMA-2600A-LSS Controllers add the following: Ammonia, Hydrogen Sulfide, Nitric Oxide, Nitrogen Trifluoride, Propylene, Nitrogen Dioxide to 0.5% in an inert carrier, Refrigerant gases.

PURE NON-CORROSIVE GASES			25°C			0°C		
Gas Number	Short Name	Long Name	Absolute Viscosity	Density 14.696 PSIA	Compressibility 14.696 PSIA	Absolute Viscosity	Density 14.696 PSIA	Compressibility 14.696 PSIA
14	C2H2	Acetylene	104.44800	1.07200	0.9928000	97.374	1.1728	0.9905
0	Air	Air	184.89890	1.18402	0.9996967	172.574	1.2930	0.9994
1	Ar	Argon	226.23990	1.63387	0.9993656	210.167	1.7840	0.9991
16	i-C4H10	i-Butane	74.97846	2.44028	0.9735331	68.759	2.6887	0.9645
13	n-C4H10	n-Butane	74.05358	2.44930	0.9699493	67.690	2.7037	0.9591
4	CO2	Carbon Dioxide	149.31840	1.80798	0.9949545	137.107	1.9768	0.9933
3	CO	Carbon Monoxide	176.49330	1.14530	0.9996406	165.151	1.2505	0.9993
60	D2	Deuterium	126.59836	0.16455	1.0005970	119.196	0.1796	1.0006
5	C2H6	Ethane	93.54117	1.23846	0.9923987	86.129	1.3550	0.9901
15	C2H4	Ethylene (Ethene)	103.18390	1.15329	0.9942550	94.697	1.2611	0.9925
7	He	Helium	198.45610	0.16353	1.0004720	186.945	0.1785	1.0005
6	H2	Hydrogen	89.15355	0.08235	1.0005940	83.969	0.0899	1.0006
17	Kr	Krypton	251.32490	3.43229	0.9979266	232.193	3.7490	0.9972
2	CH4	Methane	110.75950	0.65688	0.9982472	102.550	0.7175	0.9976
10	Ne	Neon	311.12640	0.82442	1.0004810	293.822	0.8999	1.0005
8	N2	Nitrogen	178.04740	1.14525	0.9998016	166.287	1.2504	0.9995
9	N2O	Nitrous Oxide	148.41240	1.80888	0.9945327	136.310	1.9779	0.9928
11	O2	Oxygen	205.50210	1.30879	0.9993530	191.433	1.4290	0.9990
12	C3H8	Propane	81.46309	1.83204	0.9838054	74.692	2.0105	0.9785
19	SF6	Sulfur Hexafluoride	153.53200	6.03832	0.9886681	140.890	6.6162	0.9849
18	Xe	Xenon	229.84830	5.39502	0.9947117	212.157	5.8980	0.9932

PURE CORROSIVES*			25°C			0°C		
Gas Number	Short Name	Long Name	Absolute Viscosity	Density 14.696 PSIA	Compressibility 14.696 PSIA	Absolute Viscosity	Density 14.696 PSIA	Compressibility 14.696 PSIA
32	NH3	Ammonia	100.92580	0.70352	0.9894555	91.930	0.7715	0.9848612
80	1Butene	Butylene (1-Butene)	81.62541	2.35906	0.9721251	74.354	2.6036	0.9614456
81	cButene	Cis-Butene (cis-2-butene)	79.96139	2.36608	0.9692405	Liquid	Liquid	Liquid
82	iButene	Iso-Butene	80.84175	2.35897	0.9721626	73.640	2.6038	0.9613501
83	tButene	Trans-Butene	80.28018	2.36596	0.9692902	Liquid	Liquid	Liquid
84	COS	Carbonyl Sulfide	124.09600	2.48322	0.9888443	113.127	2.7202	0.9853328
33	Cl2	Chlorine	134.56600	2.93506	0.9874470	125.464	3.1635	0.98407
85	CH3OCH3	Dimethylether	90.99451	1.91822	0.9816453	82.865	2.1090	0.9745473
34	H2S	Hydrogen Sulfide (H2S)	123.86890	1.40376	0.9923556	112.982	1.5361	0.9898858
31	NF3	NF3 (Nitrogen Trifluoride)	175.42500	2.91339	0.9963859	162.426	3.1840	0.9951506
30	NO	NO (Nitric Oxide)	190.05950	1.22672	0.9997970	176.754	1.3394	0.9995317
36	C3H6	Propylene (Propylene)	85.59895	1.74509	0.9856064	78.129	1.9139	0.9809373
86	SiH4	Silane (SiH4)	115.94400	1.32003	0.9945000	107.053	1.4433	0.99282
35	SO2	Sulfur Dioxide	127.83100	2.66427	0.9828407	116.717	2.9312	0.9750866

*Pure Corrosive gases are only available on FMA-2600A-LSS Series instruments that are compatible with these gases. Gas numbers 33 and 35 are not available on controllers

REFRIGERANTS*			25°C				0°C				
Gas Number	Short Name	Long Name	Absolute Viscosity	Density 14.696 PSIA	Compressibility 14.696 PSIA	Absolute Viscosity	Density 14.696 PSIA	Compressibility 14.696 PSIA	Absolute Viscosity	Density 14.696 PSIA	Compressibility 14.696 PSIA
100	R-11	Trichlorofluoromethane	101.60480	5.82358	0.9641448	Liquid	Liquid	Liquid	Liquid	Liquid	Liquid
101	R-115	Chloropentafluoroethane	125.14780	6.43293	0.9814628	114.891	7.0666	0.9752287	114.891	7.0666	0.9752287
102	R-116	Hexafluoroethane	137.81730	5.70097	0.9895011	126.635	6.2458	0.9858448	126.635	6.2458	0.9858448
103	R-124	Chlorotetrafluoroethane	115.93110	5.72821	0.9738286	105.808	6.3175	0.963807	105.808	6.3175	0.963807
104	R-125	Pentafluoroethane	129.61740	4.98169	0.9847599	118.793	5.4689	0.979137	118.793	5.4689	0.979137
105	R-134A	Tetrafluoroethane	118.18820	4.25784	0.9794810	108.311	4.6863	0.9713825	108.311	4.6863	0.9713825
106	R-14	Tetrafluoromethane	172.44680	3.61084	0.9962553	159.688	3.9467	0.9948964	159.688	3.9467	0.9948964
107	R-142b	Chlorodifluoroethane	104.20190	4.21632	0.9742264	95.092	4.6509	0.9640371	95.092	4.6509	0.9640371
108	R-143a	Trifluoroethane	110.86600	3.49451	0.9830011	101.344	3.8394	0.9765755	101.344	3.8394	0.9765755
109	R-152a	Difluoroethane	100.81320	2.75903	0.9785245	91.952	3.0377	0.9701025	91.952	3.0377	0.9701025
110	R-22	Difluoromonochloromethane	126.30390	3.58679	0.9853641	115.325	3.9360	0.9801128	115.325	3.9360	0.9801128
111	R-23	Trifluoromethane	149.13160	2.88404	0.9922734	136.997	3.1568	0.9895204	136.997	3.1568	0.9895204
112	R-32	Difluoromethane	126.13140	2.15314	0.9875960	115.303	2.3619	0.9827161	115.303	2.3619	0.9827161
113	RC-318	Octafluorocyclobutane	115.04690	8.42917	0.9700156	104.785	9.3017	0.9594738	104.785	9.3017	0.9594738
114	R-404A	44% R-125 / 4% R-134A / 52% R-143A	120.30982	4.18002	0.9836342	111.584	4.5932	0.9770889	111.584	4.5932	0.9770889
115	R-407C	23% R-32 / 25% R-125 / 52% R-134A	123.55369	3.95268	0.9826672	112.698	4.3427	0.9762849	112.698	4.3427	0.9762849
116	R-410A	50% R-32 / 50% R-125	130.24384	3.56538	0.9861780	122.417	3.9118	0.9811061	122.417	3.9118	0.9811061
117	R-507A	50% R-125 / 50% R-143A	121.18202	4.23876	0.9838805	112.445	4.6573	0.9774207	112.445	4.6573	0.9774207

*Refrigerant gases are only available on FMA-2600A-LSS Series instruments that are compatible with these gases.

WELDING GASES		Long Name	25°C			0°C		
Gas Number	Short Name		Absolute Viscosity	Density 14.696 PSIA	Compressibility 14.696 PSIA	Absolute Viscosity	Density 14.696 PSIA	Compressibility 14.696 PSIA
23	C-2	2% CO2 / 98% Ar	224.71480	1.63727	0.9993165	208.673	1.7877	0.998993
22	C-8	8% CO2 / 92% Ar	220.13520	1.64749	0.9991624	204.199	1.7989	0.9987964
21	C-10	10% CO2 / 90% Ar	218.60260	1.65091	0.9991086	202.706	1.8027	0.9987278
140	C-15	15% CO2 / 85% Ar	214.74960	1.65945	0.9989687	198.960	1.8121	0.9985493
141	C-20	20% CO2 / 80% Ar	210.86960	1.66800	0.9988210	195.198	1.8215	0.9983605
20	C-25	25% CO2 / 75% Ar	206.97630	1.67658	0.9986652	191.436	1.8309	0.9981609
142	C-50	50% CO2 / 50% Ar	187.53160	1.71972	0.9977484	172.843	1.8786	0.9969777
24	C-75	75% CO2 / 25% Ar	168.22500	1.76344	0.9965484	154.670	1.9271	0.995401
25	He-25	25% He / 75% Ar	231.60563	1.26598	0.9996422	216.008	1.3814	0.9999341
143	He-50	50% He / 50% Ar	236.15149	0.89829	0.9999188	220.464	0.9800	1.00039
26	He-75	75% He / 25% Ar	234.68601	0.53081	1.0001954	216.937	0.5792	1.000571
144	He-90	90% He / 10% Ar	222.14566	0.31041	1.0003614	205.813	0.3388	1.00057
27	A1025	90% He / 7.5% Ar / 2.5% CO2	214.97608	0.31460	1.0002511	201.175	0.3433	1.000556
28	Star29	Stargon C5 90% Ar / 8% CO2 / 2% O2	219.79340	1.64099	0.9991638	203.890	1.7918	0.998798

BIOREACTOR GASES			25°C				0°C			
Gas Number	Short Name	Long Name	Absolute Viscosity	Density 14.696 PSIA	Compressibility 14.696 PSIA	Absolute Viscosity	Density 14.696 PSIA	Compressibility 14.696 PSIA		
145	Bio-5M	5% CH4 / 95% CO2	148.46635	1.75026	0.9951191	136.268	1.9134	0.9935816		
146	Bio-10M	10% CH4 / 90% CO2	147.54809	1.69254	0.9952838	135.383	1.8500	0.993893		
147	Bio-15M	15% CH4 / 85% CO2	146.55859	1.63484	0.9954484	134.447	1.7867	0.9941932		
148	Bio-20M	20% CH4 / 80% CO2	145.49238	1.57716	0.9956130	133.457	1.7235	0.994482		
149	Bio-25M	25% CH4 / 75% CO2	144.34349	1.51950	0.9957777	132.407	1.6603	0.9947594		
150	Bio-30M	30% CH4 / 70% CO2	143.10541	1.46186	0.9959423	131.290	1.5971	0.9950255		
151	Bio-35M	35% CH4 / 65% CO2	141.77101	1.40424	0.9961069	130.102	1.5340	0.9952803		
152	Bio-40M	40% CH4 / 60% CO2	140.33250	1.34664	0.9962716	128.834	1.4710	0.9955239		
153	Bio-45M	45% CH4 / 55% CO2	138.78134	1.28905	0.9964362	127.478	1.4080	0.9957564		
154	Bio-50M	50% CH4 / 50% CO2	137.10815	1.23149	0.9966009	126.025	1.3450	0.9959779		
155	Bio-55M	55% CH4 / 45% CO2	135.30261	1.17394	0.9967655	124.462	1.2821	0.9961886		
156	Bio-60M	60% CH4 / 40% CO2	133.35338	1.11642	0.9969301	122.779	1.2193	0.9963885		
157	Bio-65M	65% CH4 / 35% CO2	131.24791	1.05891	0.9970948	120.959	1.1564	0.9965779		
158	Bio-70M	70% CH4 / 30% CO2	128.97238	1.00142	0.9972594	118.987	1.0936	0.9967567		
159	Bio-75M	75% CH4 / 25% CO2	126.51146	0.94395	0.9974240	116.842	1.0309	0.9969251		
160	Bio-80M	80% CH4 / 20% CO2	123.84817	0.88650	0.9975887	114.501	0.9681	0.9970832		
161	Bio-85M	85% CH4 / 15% CO2	120.96360	0.82907	0.9977533	111.938	0.9054	0.9972309		
162	Bio-90M	90% CH4 / 10% CO2	117.83674	0.77166	0.9979179	109.119	0.8427	0.9973684		
163	Bio-95M	95% CH4 / 5% CO2	114.44413	0.71426	0.9980826	106.005	0.7801	0.9974957		

BREATHING GASES			25°C			0°C		
Gas Number	Short Name	Long Name	Absolute Viscosity	Density 14.696 PSIA	Compressibility 14.696 PSIA	Absolute Viscosity	Density 14.696 PSIA	Compressibility 14.696 PSIA
164	EAN-32	32% O ₂ / 68% N ₂	186.86315	1.19757	0.9996580	174.925	1.3075	0.9993715
165	EAN	36% O ₂ / 64% N ₂	187.96313	1.20411	0.9996401	175.963	1.3147	0.9993508
166	EAN-40	40% O ₂ / 60% N ₂	189.06268	1.21065	0.9996222	176.993	1.3218	0.9993302
167	HeOx-20	20% O ₂ / 80% He	217.88794	0.39237	1.0002482	204.175	0.4281	1.000593
168	HeOx-21	21% O ₂ / 79% He	218.15984	0.40382	1.0002370	204.395	0.4406	1.000591
169	HeOx-30	30% O ₂ / 70% He	219.24536	0.50683	1.0001363	205.140	0.5530	1.000565
170	HeOx-40	40% O ₂ / 60% He	218.59913	0.62132	1.0000244	204.307	0.6779	1.000502
171	HeOx-50	50% O ₂ / 50% He	216.95310	0.73583	0.9999125	202.592	0.8028	1.000401
172	HeOx-60	60% O ₂ / 40% He	214.82626	0.85037	0.9998006	200.467	0.9278	1.000257
173	HeOx-80	80% O ₂ / 20% He	210.11726	1.07952	0.9995768	195.872	1.1781	0.9998019
174	HeOx-99	99% O ₂ / 1% He	205.72469	1.29731	0.9993642	191.646	1.4165	0.9990796
175	EA-40	Enriched Air-40% O ₂	189.42518	1.21429	0.9996177	177.396	1.3258	0.9993261
176	EA-60	Enriched Air-60% O ₂	194.79159	1.24578	0.9995295	182.261	1.3602	0.9992266
177	EA-80	Enriched Air-80% O ₂	200.15060	1.27727	0.9994412	186.937	1.3946	0.9991288
178	Metabol	Metabolic Exhalant (16% O ₂ / 78.04% N ₂ / 5% CO ₂ / 0.96% Ar)	180.95936	1.20909	0.9994833	170.051	1.3200	0.9992587

FUEL GASES			25°C				0°C		
Gas Number	Short Name	Long Name	Absolute Viscosity	Density 14.696 PSIA	Compressibility 14.696 PSIA	Absolute Viscosity	Density 14.696 PSIA	Compressibility 14.696 PSIA	
185	Syn Gas-1	40% H2 + 29% CO + 20% CO2 + 1% CH4	155.64744	0.79774	0.9989315	144.565	0.8704	0.9992763	
186	Syn Gas-2	64% H2 + 28% CO + 1% CO2 + 7% CH4	151.98915	0.43715	1.0001064	142.249	0.4771	1.000263	
187	Syn Gas-3	70% H2 + 4% CO + 25% CO2 + 1% CH4	147.33686	0.56024	0.9991225	136.493	0.6111	0.9997559	
188	Syn Gas-4	88% H2 + 14% CO + 3% CH4	133.63682	0.24825	1.0003901	125.388	0.2709	1.000509	
189	Nat Gas-1	93% CH4 / 3% C2H6 / 1% C3H8 / 2% N2 / 1% CO2	111.77027	0.70709	0.9979255	103.189	0.7722	0.9973965	
190	Nat Gas-2	95% CH4 / 3% C2H6 / 1% N2 / 1% CO2	111.55570	0.69061	0.9980544	103.027	0.7543	0.9974642	
191	Nat Gas-3	95.2% CH4 / 2.5% C2H6 / 0.2% C3H8 / 0.1% C4H10 / 1.3% N2 / 0.7% CO2	111.49608	0.68980	0.9980410	102.980	0.7534	0.9974725	
192	Coal Gas	50% H2 / 35% CH4 / 10% CO / 5% C2H4	123.68517	0.44281	0.9993603	115.045	0.6589	0.996387	
193	Endo	75% H2 + 25% N2	141.72100	0.34787	1.0005210	133.088	0.3797	1.000511	
194	HHO	66.67% H2 / 33.33% O2	180.46190	0.49078	1.0001804	168.664	0.5356	1.000396	
195	HD-5	LPG 96.1% C3H8 / 1.5% C2H6 / 0.4% C3H6 / 1.9% n-C4H10	81.45829	1.83428	0.9836781	74.933	2.0128	0.9784565	
196	HD-10	LPG 85% C3H8 / 10% C3H6 / 5% n-C4H10	81.41997	1.85378	0.9832927	74.934	2.0343	0.9780499	

LASER GASES			25°C				0°C		
Gas Number	Short Name	Long Name	Absolute Viscosity	Density 14.696 PSIA	Compressibility 14.696 PSIA	Absolute Viscosity	Density 14.696 PSIA	Compressibility 14.696 PSIA	
179	LG-4.5	4.5% CO2 / 13.5% N2 / 82% He	199.24300	0.36963	1.0001332	187.438	0.4033	1.000551	
180	LG-6	6% CO2 / 14% N2 / 80% He	197.87765	0.39910	1.0000471	186.670	0.4354	1.00053	
181	LG-7	7% CO2 / 14% N2 / 79% He	197.00519	0.41548	0.9999919	186.204	0.4533	1.000514	
182	LG-9	9% CO2 / 15% N2 / 76% He	195.06655	0.45805	0.9998749	184.835	0.4997	1.000478	
183	HeNe-9	9% Ne / 91% He	224.68017	0.22301	1.0004728	211.756	0.2276	1.000516	
184	LG-9.4	9.4% CO2 / 19.25% N2 / 71.35% He	193.78311	0.50633	0.9998243	183.261	0.5523	1.000458	

O2 CONCENTRATOR GASES				25°C			0°C		
Gas Number	Short Name	Long Name	Absolute Viscosity	Density 14.696 PSIA	Compressibility 14.696 PSIA	Absolute Viscosity	Density 14.696 PSIA	Compressibility 14.696 PSIA	
197	OCG-89	89% O2 / 7% N2 / 4% Ar	204.53313	1.31033	0.9993849	190.897	1.4307	0.9990695	
198	OCG-93	93% O2 / 3% N2 / 4% Ar	205.62114	1.31687	0.9993670	191.795	1.4379	0.9990499	
199	OCG-95	95% O2 / 1% N2 / 4% Ar	206.16497	1.32014	0.9993580	192.241	1.4414	0.99904	

STACK GASES				25°C			0°C		
Gas Number	Short Name	Long Name	Absolute Viscosity	Density 14.696 PSIA	Compressibility 14.696 PSIA	Absolute Viscosity	Density 14.696 PSIA	Compressibility 14.696 PSIA	
200	FG-1	2.5% O2 / 10.8% CO2 / 85.7% N2 / 1% Ar	175.22575	1.22550	0.9992625	165.222	1.3379	0.9990842	
201	FG-2	2.9% O2 / 14% CO2 / 82.1% N2 / 1% Ar	174.18002	1.24729	0.9991056	164.501	1.3617	0.9989417	
202	FG-3	3.7% O2 / 15% CO2 / 80.3% N2 / 1% Ar	174.02840	1.25520	0.9990536	164.426	1.3703	0.9988933	
203	FG-4	7% O2 / 12% CO2 / 80% N2 / 1% Ar	175.95200	1.24078	0.9991842	166.012	1.3546	0.9990116	
204	FG-5	10% O2 / 9.5% CO2 / 79.5% N2 / 1% Ar	177.65729	1.22918	0.9992919	167.401	1.3419	0.9991044	
205	FG-6	13% O2 / 7% CO2 / 79% N2 / 1% Ar	179.39914	1.21759	0.9993996	168.799	1.3293	0.9991932	

CHROMATOGRAPHY GASES				25°C			0°C		
Gas Number	Short Name	Long Name	Absolute Viscosity	Density 14.696 PSIA	Compressibility 14.696 PSIA	Absolute Viscosity	Density 14.696 PSIA	Compressibility 14.696 PSIA	
29	P-5	5% CH4 / 95% Ar	223.91060	1.58505	0.9993265	207.988	1.7307	0.9990036	
206	P-10	10% CH4 90% Ar	221.41810	1.53622	0.9992857	205.657	1.6774	0.99895	

Supported Units: This device supports many different units. You may select the desired units (see page 28). Note that only units appropriate to this device are available for selection.

Pressure Units

Absolute	Gauge	Differential	Notes
PaA	PaG	PaD	pascal
hPaA	hPaG	hPaD	hectopascal
kPaA	kPaG	kPaD	kilopascal
MPaA	MPaG	MPaD	megapascal
mbarA	mbarG	mbarD	millibar
barA	barG	barD	bar
g/cm2A	g/cm2G	g/cm2D	gram force per square centimeter
kg/cmA	kg/cmG	kg/cmD	kilogram force per square centimeter
PSIA	PSIG	PSID	pound force per square inch
PSFA	PSFG	PSFD	pound force per square foot
mTorrA	mTorrG	mTorrD	millitorr
torrA	torrG	torrD	torr
mmHgA	mmHgG	mmHgD	millimeter of mercury at 0 C
inHgA	inHgG	inHgD	inch of mercury at 0 C
mmH2OA	mmH2OG	mmH2OD	millimeter of water at 4 C (NIST conventional)
mmH2OA	mmH2OG	mmH2OD	millimeter of water at 60 C
cmH2OA	cmH2OG	cmH2OD	centimeter of water at 4 C (NIST conventional)
cmH2OA	cmH2OG	cmH2OD	centimeter of water at 60 C
inH2OA	inH2OG	inH2OD	inch of water at 4 C (NIST conventional)
inH2OA	inH2OG	inH2OD	inch of water at 60 C
atm			atmosphere
m asl			meter above sea level (only in /ALT builds)
ft asl			foot above sea level (only in /ALT builds)
V	volt; no conversions are performed to or from other units		
count	count	count	setpoint count, 0 – 64000
%	%	%	percent of full scale

Flow Units

Volumetric	Standard	Normal	Notes
uL/m	SuL/m	NuL/m	microliter per minute
mL/s	SmL/s	NmL/s	milliliter per second
mL/m	SmL/m	NmL/m	milliliter per minute
mL/h	SmL/h	NmL/h	milliliter per hour
L/s	SL/s	NL/s	liter per second
LPM	SLPM	NLPM	liter per minute
L/h	SL/h	NL/h	liter per hour
US GPM			US gallon per minute
US GPH			US gallon per hour
CCS	SCCS	NCCS	cubic centimeter per second
CCM	SCCM	NCCM	cubic centimeter per minute
cm3/h	Scm3/h	Ncm3/h	cubic centimeter per hour
m3/m	Sm3/m	Nm3/m	cubic meter per minute
m3/h	Sm3/h	Nm3/h	cubic meter per hour
m3/d	Sm3/d	Nm3/d	cubic meter per day
in3/m	Sin3/m		cubic inch per minute
CFM	SCFM		cubic foot per minute
CFH	SCFH		cubic foot per hour
	kSCFM		1000 cubic feet per minute
count	count	count	setpoint count, 0 – 64000
%	%	%	percent of full scale

True Mass Flow Units

Label	Notes
mg/s	milligram per second
mg/m	milligram per minute
g/s	gram per second
g/m	gram per minute
g/h	gram per hour
kg/m	kilogram per minute
kg/h	kilogram per hour
oz/s	ounce per second
oz/m	ounce per minute
lb/m	pound per minute
lb/h	pound per hour

These can be used for mass flow on gas devices. These can also be used for volumetric flow on liquid devices calibrated in one of these units (liquid density is not yet supported).

Totalizer Units

Volumetric	Standard	Normal	Notes
uL	SuL	NuL	microliter
mL	SmL	NmL	milliliter
L	SL	NL	liter
US GAL			US gallon
cm3	Scm3	Ncm3	cubic centimeter
m3	Sm3	Nm3	cubic meter
in3	Sin3		cubic inch
ft3	Sft3		cubic foot
	kSft3		1000 cubic feet
uP	micropoise, a measure of viscosity; no conversions are performed to or from other units		

Total Mass Units

Label	Notes
mg	milligram
g	gram
kg	kilogram
oz	ounce
lb	pound

These can be used for totalized mass on gas devices. These can also be used for totalized volume on liquid devices calibrated in one of these units (liquid density is not yet supported).

Temperature Units

Label	Notes
°C	degree Celsius
°F	degree Fahrenheit
K	Kelvin
°R	degree Rankine

Time Units

Label	Notes
h:m:s	Displayed value is hours:minutes:seconds
ms	millisecond
s	second
m	minute
hour	hour
day	day

Valve Drive Units

Label	Notes
count	+/- 65536 at full drive
%	Percent of full scale drive

TROUBLESHOOTING

Display does not come on or is weak.

Check power and ground connections. Please reference the technical specifications (pages 56 - 71) to assure you have the proper power for your model.

Flow reading is approximately fixed either near zero or near full scale regardless of actual line flow.

Differential pressure sensor may be damaged. A common cause of this problem is instantaneous application of high-pressure gas as from a snap acting solenoid valve upstream of the meter. If you suspect that your pressure sensor is damaged please discontinue use of the controller and contact Omega.

Displayed mass flow, volumetric flow, pressure or temperature is flashing and message MOV, VOV, POV or TOV is displayed:

Our flow meters and controllers display an error message (MOV = mass overrange, VOV = volumetric overrange, POV = pressure overrange, TOV = temperature overrange) when a measured parameter exceeds the range of the sensors in the device. When any item flashes on the display, neither the flashing parameter nor the mass flow measurement is accurate. Reducing the value of the flashing parameter to within specified limits will return the unit to normal operation and accuracy. If the unit does not return to normal contact Omega.

After installation, there is no flow.

FMA-2600A controllers incorporate normally closed valves and require a set-point to operate. Check that your set-point signal is present and supplied to the correct pin and that the correct set-point source is selected under the SETPT SOURCE list in the control set up display. Also check that the unit is properly grounded.

The flow lags below the set-point.

Be sure there is enough pressure available to make the desired flow rate. If either the set-point signal line and/or the output signal line is relatively long, it may be necessary to provide heavier wires (especially ground wiring) to negate voltage drops due to line wire length. An inappropriate PID tuning can also cause this symptom if the D term is too large relative to the P term. See pages 18 and 19 for more information on PID tuning.

Controller is slow to react to a set-point change or imparts an oscillation to the flow.

An inappropriate PID tuning can cause these symptoms. Use at conditions considerably different than those at which the device was originally set up can necessitate a re-tuning of the PID loop. See pages 20 and 21 for more information on PID tuning.

The output signal is lower than the reading at the display.

This can occur if the output signal is measured some distance from the meter, as voltage drops in the wires increase with distance. Using heavier gauge wires, especially in the ground wire, can reduce this effect.

Meter does not agree with another meter I have in line.

Volumetric meters are affected by pressure drops. Volumetric flow meters should not be compared to mass flow meters. Mass flow meters can be compared against one another provided there are no leaks between the two meters and they are set to the same standard temperature and pressure. Both meters must also be calibrated (or set) for the gas being measured. FMA-1600A mass flow meters are normally set to Standard Temperature and Pressure conditions of 25° C and 14.696 psia. Note: it is possible to special order meters with a customer specified set of standard conditions. The calibration sheet provided with each meter lists its standard conditions.

When performing this comparison it is best to use the smallest transition possible between the two devices. Using small transitions will minimize lag and dead volume.

RS232 / RS485 Serial Communications is not responding.

Check that your meter is powered and connected properly. Be sure that the port on the computer to which the meter is connected is active. Confirm that the port settings are correct per the RS232 instructions in this manual (Check the RS232 / RS485 communications select screen for current meter readings). Close Hyperterminal® and reopen it. Reboot your PC. See pages 10, 11 and 30 for more information on RS232 / RS485 signals and communications.

Slower response than specified.

FMA-2600A Controllers feature a programmable Geometric Running Average (GRA). Depending on the full scale range of the meter, it may have the GRA set to enhance the stability/readability of the display, which would result in slower perceived response time. Please see “Pressure Averaging” and “Flow Averaging” on page 26.

Jumps to zero at low flow.

FMA-2600A Controllers feature a programmable zero deadband. The factory setting is usually 0.5% of full scale. This can be adjusted between NONE and 6.3% of full scale. See page 26.

Discrepancies between old and new units.

Please see “Standard Gas Data Tables” explanation on page 38.

Maintenance and Recalibration

General: FMA-2600A Flow Controllers require minimal maintenance. They have no moving parts. The single most important thing that affects the life and accuracy of these devices is the quality of the gas being measured. The controller is designed to measure CLEAN, DRY, NON-CORROSIVE gases.

Moisture, oil and other contaminants can affect the laminar flow elements. We recommend the use of in-line sintered filters to prevent large particulates from entering the measurement head of the instrument. Suggested maximum particulate sizes are as follows:

- 5 microns for units with FS flow ranges of 0-1 sccm or less.

- 20 microns for units with FS flow ranges between 0-2 sccm and 0-1 slpm.

- 50 microns for units with FS flow ranges of 0-1 slpm or more.

Recalibration: The recommended period for recalibration is once every year. A label located on the back of the controller lists the most recent calibration date. The controller should be returned to the factory for recalibration within one year from the listed date. Before calling to schedule a recalibration, please note the serial number on the back of the instrument. The Serial Number, Model Number, and Date of Manufacture are also available on the Model Info display (page 29).

Cleaning: FMA-2600A Flow Controllers require no periodic cleaning. If necessary, the outside of the controller can be cleaned with a soft dry cloth. Avoid excess moisture or solvents.

For repair, recalibration or recycling of this product contact Omega.

Option: Totalizing Mode - Controllers

Controllers can be purchased with the Totalizing Mode option. This option adds an additional mode screen that displays the total flow (normally in the units of the main flow screen) that has passed through the device since the last time the totalizer was cleared. The Totalizing Mode screen is accessed by pushing the **TOTAL/TIMER** button on the **MAIN** display.

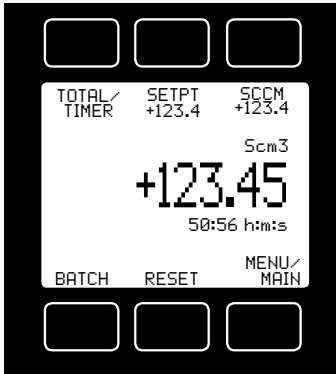

TOTAL/TIMER: Pushing the TOTAL/TIMER button will cycle the large numbers on the display between total mass and time elapsed.

Rollover – The customer can also specify at the time of order what the totalizer is to do when the maximum count is reached. The following options may be specified:

No Rollover – When the counter reaches the maximum count it stops counting until the counter is cleared.

Rollover – When the counter reaches the maximum count it automatically rolls over to zero and continues counting until the counter is cleared.

Rollover with Notification – When the counter reaches the maximum count it automatically rolls over to zero, displays an overflow error, and continues counting until the counter is cleared.

TOTAL MASS: The counter can have as many as seven digits. At the time of order, the customer must specify the range. This directly affects the maximum count. For instance, if a range of 1/100ths of a liter is specified on a meter which is totalizing in liters, the maximum count would be 99999.99 liters. If the same unit were specified with a 1 liter range, the maximum count would be 9999999 liters.

ELAPSED TIME: The small numbers below the mass total show the elapsed time since the last reset in hours, minutes and seconds. The maximum measurable elapsed time is 9999 hours 59 minutes 59 seconds. The hours count resets when **RESET** is pushed, an RS232 or RS485 clear is executed or on loss of power. Press **TOTAL/TIMER** to show this as the primary display.

SETPT: Pushing SETPT will allow you to change the controller's set-point.

RESET – The counter can be reset to zero at any time by pushing the RESET button. To clear the counter via RS232 or RS485, establish serial communication with the meter or controller as described in the RS232 or RS485 section of the manual. To reset the counter, enter the following commands:

In Polling (addressable) Mode: Address\$\$T <Enter> (e.g. B\$\$T <Enter>)



WHEN USING A MASS FLOW CONTROLLER AS AN ABSOLUTE PRESSURE CONTROLLER, THE MASS FLOW RATE MAY MOMENTARILY EXCEED THE FLOW MEASUREMENT CAPABILITY (FULL SCALE + 28%) OF THE UNIT. THIS MAY OCCUR WHEN THE UNIT IS ASKED TO MAKE AN ABRUPT PRESSURE CHANGE.

IF THE TOTALIZER IS IN USE AT THAT TIME, THE TOTALIZED VALUE WILL NECESSARILY BECOME INCORRECT. PLEASE RESET THE TOTALIZER IF SUCH AN 'OVER-FLOW' CONDITION HAS OCCURRED.

BATCH PROCESSING MODE – CONTROLLERS ONLY

Batch mode is a function within the optional Totalizing mode. Batch mode is designed to provide repeatable, finite flow quantities.

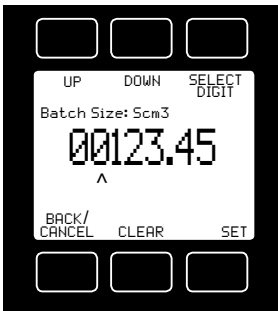

To activate Batch Mode: Press **BATCH**. Then use **SELECT DIGIT** to move the arrow to the desired digit, and the UP and DOWN buttons to change the value. Press **CLEAR** to return to zero. Press **SET** to record your value. If the controller has a non-zero Set-Point, flow will start immediately. If not, press **SETPT** to select a Set-Point.

Batch values can also be established via RS232/RS485 communication using Register 92. (See RS232/RS485 Section of this manual for serial communication methods.)

Note: While the Totalizer counter will still reset across power cycles, the Batch process value is stored in EEPROM and will remain valid until updated by the user.

While the Batch is processing, the remaining amount of the Batch value is displayed above **REMAIN** on the Totalizer screen. Time elapsed during the Batch processing is displayed below the totalizing counter. Press **TOTAL/TIMER** to toggle these values.

When the active Totalizer reaches the preset Batch value, flow ceases, and **REMAIN** updates to **Done Batch**. The Totalizer timer also pauses.



- **To start a new batch of the same size**, simply press RESET. The Totalizer can reproduce any number of fixed Batches in this manner.

- **To start a smaller batch**, decrease the Batch value. The new batch begins when you press RESET.

- **To continue the existing batch to a larger total volume**, increase the Batch value. Flow resumes as soon as you press OK in the Batch Value screen.

- **To start a larger batch from scratch**, first clear the flow Set-Point to zero to prevent unwanted flow.

Then increase the Batch value, and select a flow Set-Point. Flow will begin when you press **SET** in the Set-Point screen.

- **To cancel a batch in progress**, clear the Set-Point and press **SET**.

Note: Batch mode operates independently of the desired flow rate, but requires a non-zero flow rate to run. The rate of flow is determined by the controller Set-Point value, which is established by the user via analog, front panel or serial communication methods. Batches can be produced more slowly or more rapidly as determined by the user-selected Set-Point flow rate.

To turn off Batch Mode: Set the Batch value to zero (0.0) via the front panel or RS232/RS485 communication using Register 92. If there is a non-zero flow Set-Point, flow will immediately resume, and the Totalizer counter will continue per the user established Set-Point flow rate.

Accessory: FMA1600-MDB Multi-Drop Box



The **FMA1600-MDB Multi-Drop Box** makes it convenient to wire multiple flow and/or pressure devices to a single RS232 or RS485 port.

Now available with a USB interface!

The Multi-Drop Box has nine 8 pin mini-DIN ports available. The ports are to be used with a standard double ended 8 pin mini-DIN style cable going from the box to each flow or pressure device.

A single DB9 D-SUB type connector (COM PORT) connects, using the included cable, to the serial connector on a PC or laptop.

All of the flow and/or pressure devices are powered via a terminal block on the front of the box.

If more than nine devices will be required, additional Multi-Drop Boxes can be daisy chained together with a double ended 8 pin mini-DIN cable plugged into any receptacle on both boxes.

Multi-Drop Box Power Supply for Large Valve Controllers: The PS24VHC (Power Supply 24Vdc High Current) is a 6.5Amp 24Vdc power supply designed for running multiple large controllers on a Multi-Drop Box.

The 6.5Amp power supply can run as many as 8 large valve controllers, which makes it ideal for the Multi-Drop Box and multiple large valve (or small valve / large valve combination) controllers on a Multi-Drop Box.

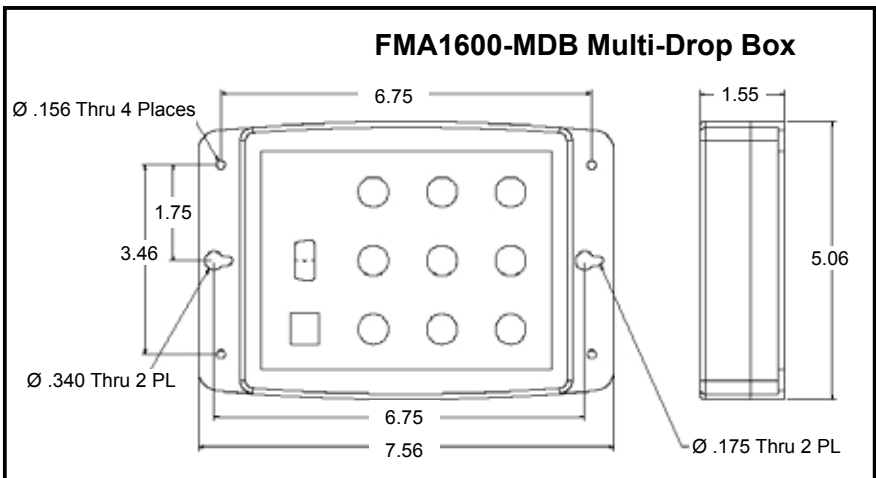

Accessories

Part Number	Description
FMA1600-C1	8 Pin Male Mini-DIN connector cable, single ended, 6 foot length
FMA1600-C2	8 Pin Male Mini-DIN connector cable, double ended, 6 foot length
FMA1600-C3	8 Pin Male Mini-DIN to DB9 Female Adapter, 6 foot length
FMA1600-PSU	Universal 100-240 VAC to 24 Volt DC Power Supply Adapter
FMA1600-CRA	8 Pin Male Right Angle Mini-Din Cable, single ended, 6 foot length
FMA1600-C1-25FT	8 Pin Male Mini-DIN connector cable, single ended, 25 foot length
FMA1600-C2-25FT	8 Pin Male Mini-DIN connector cable, double ended, 25 foot length
FMA1600-MDB	Multi-Drop Box

Technical Data for FMA-2600A Mass Flow Controllers 0 to 0.5 sccm Full Scale through 0 to 3000 slpm Full Scale

Standard Operating Specifications (Contact Omega for available options)

Performance	FMA-2600A Mass Flow Controller
Accuracy at calibration conditions after tare	± (0.8% of Reading + 0.2% of Full Scale)
High Accuracy at calibration conditions after tare	± (0.4% of Reading + 0.2% of Full Scale) High Accuracy option not available for units ranged under 5 sccm or over 500 slpm.
Repeatability	± 0.2% Full Scale
Zero Shift and Span Shift	0.02% Full Scale / °Celsius / Atm
Operating Range / Turndown Ratio	0.5% to 100% Full Scale / 200:1 Turndown
Maximum Controllable Flow Rate	102.4% Full Scale
Typical Response Time	100 ms (Adjustable)
Warm-up Time	< 1 Second

Operating Conditions	FMA-2600A Mass Flow Controller
Mass Reference Conditions (STP)	25°C & 14.696 psia (standard — others available on request)
Operating Temperature	-10 to +50 °Celsius
Humidity Range (Non-Condensing)	0 to 100%
Maximum Pressure	145 psig
Mounting Attitude Sensitivity	Small Valve: None Large Valve: Mount with valve cylinder vertical & upright
Valve Type	Normally Closed
Ingress Protection	IP40
Wetted Materials	Small Valve: 303 & 302 Stainless Steel, FKM, Heat Cured Silicone Rubber, Glass Reinforced Polyphenylene Sulfide, Heat Cured Epoxy, Aluminum, Gold, Brass, 430FR Stainless Steel, Silicon, Glass. Large Valve: 303 & 302 Stainless Steel, FKM, Heat Cured Silicone Rubber, Glass Reinforced Polyphenylene Sulfide, Heat Cured Epoxy, Aluminum, Gold, 416 Stainless Steel, Silicon, Glass. If your application demands a different material, please contact Omega.

Communications / Power	FMA-2600A Mass Flow Controller
Monochrome LCD Display with integrated touchpad	Simultaneously displays Mass Flow, Volumetric Flow, Pressure and Temperature
Digital Input/Output Signal ¹ Options	RS232 Serial / RS485 Serial
Analog Input/Output Signal ² Options	0-5 Vdc / 1-5 Vdc / 0-10 Vdc / 4-20 mA
Optional Secondary Analog Input/Output Signal ²	0-5 Vdc / 1-5 Vdc / 0-10 Vdc / 4-20 mA
Electrical Connection Options	8 Pin Mini-DIN / 15-pin D-sub (DB15)
Supply Voltage	Small Valve: 12 to 30 Vdc (15-30 Vdc for 4-20 mA outputs) Large Valve: 24 to 30 Vdc
Supply Current	Small Valve: 0.250 Amp Large Valve: 0.750 Amp
1. The Digital Output Signal communicates Mass Flow, Volumetric Flow, Pressure and Temperature 2. The Analog Output Signal and Optional Secondary Analog Output Signal communicate your choice of Mass Flow, Volumetric Flow, Pressure or Temperature	

Range Specific Specifications

Full Scale Flow Mass Controller	Pressure Drop ¹ at FS Flow (psid) venting to atmosphere	Mechanical Dimensions	Process Connections ²
0.5 sccm to 50 sccm	1.0	3.9"H x 3.4"W x 1.1"D	M-5 (10-32) Female Thread
100 sccm to 500 sccm	1.0	4.1"H x 3.6"W x 1.1"D	1/8" NPT Female
1 slpm	1.5		
2 slpm	3.0		
5 slpm	2.0		
10 slpm	5.5		
20 slpm	20.0		
50 slpm	9.0		
100 slpm	11.7	4.4"H x 6.4"W x 2.3"D	1/4" NPT Female
250 slpm	2.4	5.5"H x 7.4"W x 2.3"D	3/4" NPT Female (A 1-1/4" NPT Female process connection is available for 2000 slpm controllers.)
500 slpm	6.5		
1000 slpm	14.0		
1500 slpm	17.0		
2000 slpm	28.6		
3000 slpm	16.8	5.5"H x 8.1" W x 2.9" D	1-1/4" NPT Female
		5.5"H x 8.9" W x 2.9" D	
1. Lower Pressure Drops Available, please contact Omega. 2. Compatible with Swagelok® tube, Parker®, face seal, push connect and compression adapter fittings. VCR and SAE connections upon request.			

FMA-2600A

Upstream Valve

- 0 - 0.5 sccm
- 0 - 1 sccm
- 0 - 2 sccm
- 0 - 5 sccm
- 0 - 10 sccm
- 0 - 20 sccm
- 0 - 50 sccm

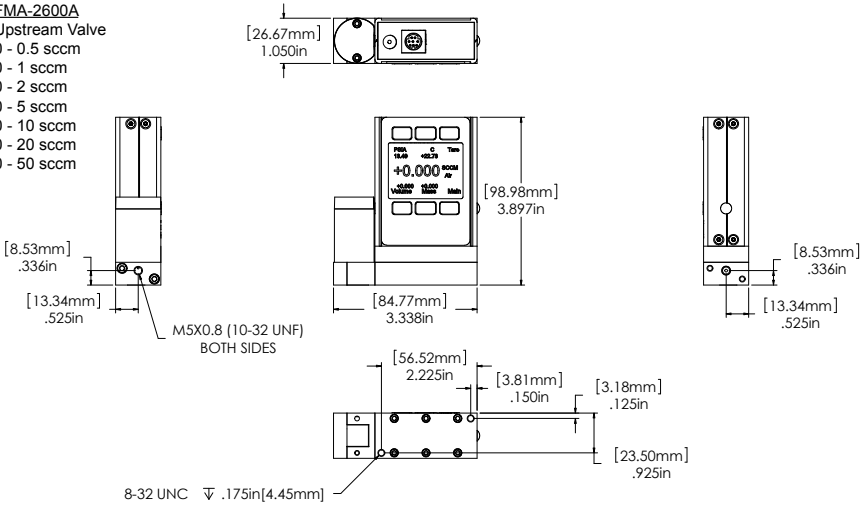

0.5 sccm to 50 sccm approximate shipping weight: 1.1 lb.

FMA-2600A

Downstream Valve*

- 0 - 0.5 sccm
- 0 - 1 sccm
- 0 - 2 sccm
- 0 - 5 sccm
- 0 - 10 sccm
- 0 - 20 sccm
- 0 - 50 sccm

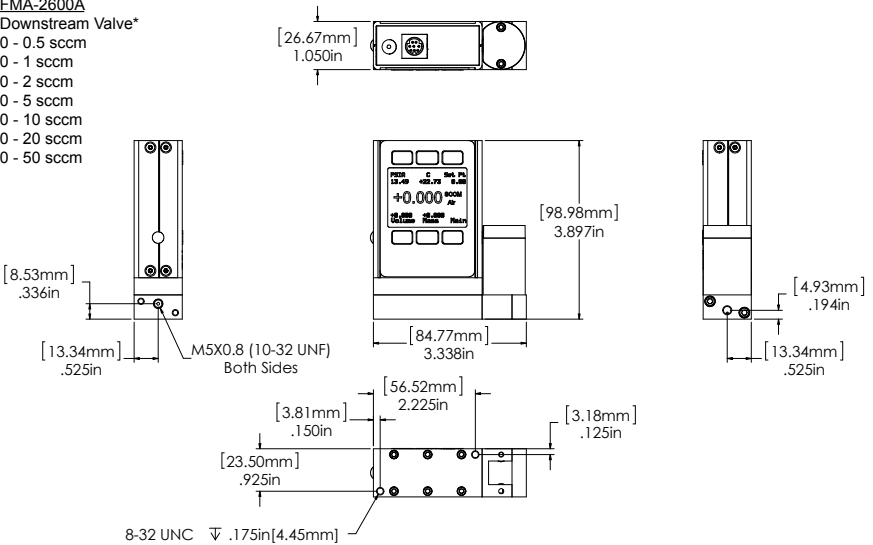

* Note process connection port locations for downstream valve in this flow range.

0.5 sccm to 50 sccm approximate shipping weight: 1.1 lb.

FMA-2600A

- 0 - 100 sccm
- 0 - 200 sccm
- 0 - 500 sccm
- 0 - 1 slpm
- 0 - 2 slpm
- 0 - 3 slpm
- 0 - 5 slpm
- 0 - 10 slpm
- 0 - 20 slpm

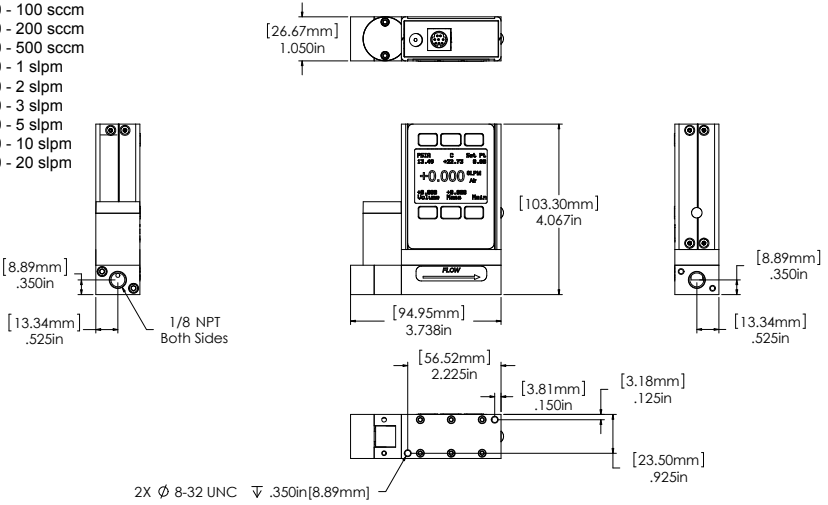

100 sccm to 20 slpm approximate weight: 1.2lb

FMA-2600A

- 0 - 50 slpm
- 0 - 100 slpm

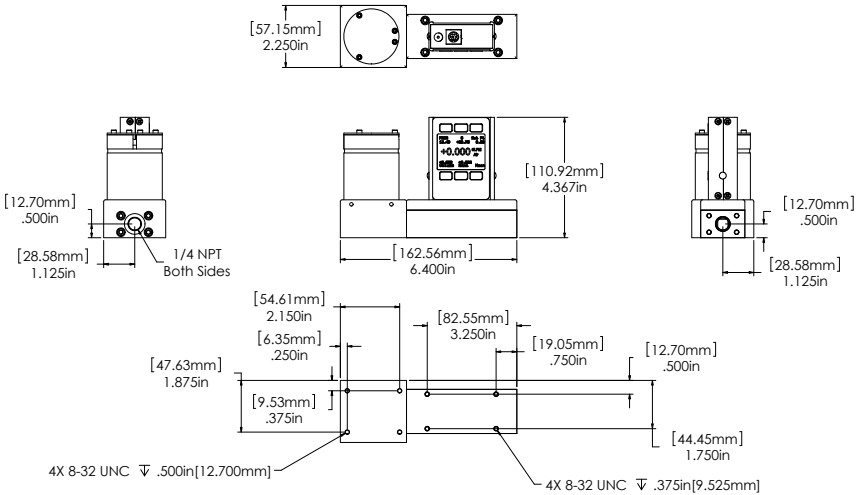

50 slpm to 100 slpm approximate weight: 7.0 lb.

FMA-2600A
0 - 250 slpm

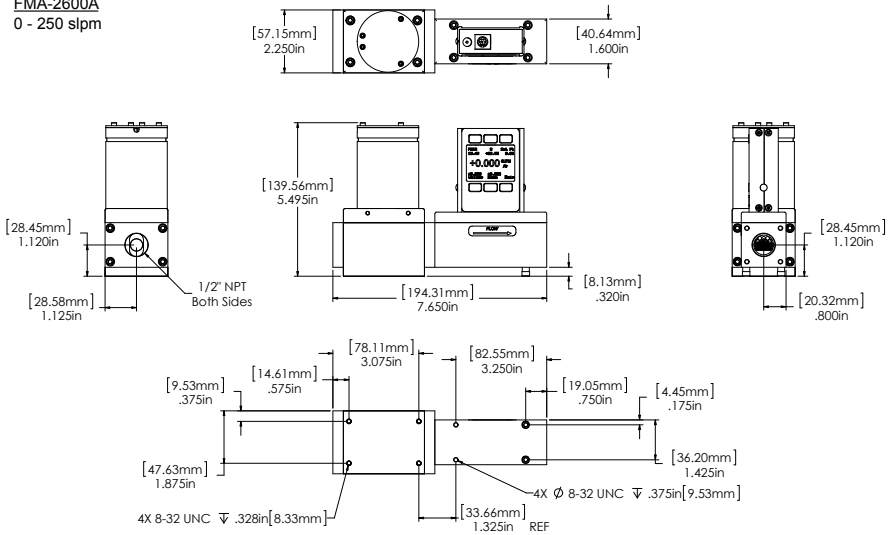

250 slpm approximate weight: 9.0 lb.

FMA-2600A
0 - 500 slpm
0 - 1000 slpm
0 - 1500 slpm

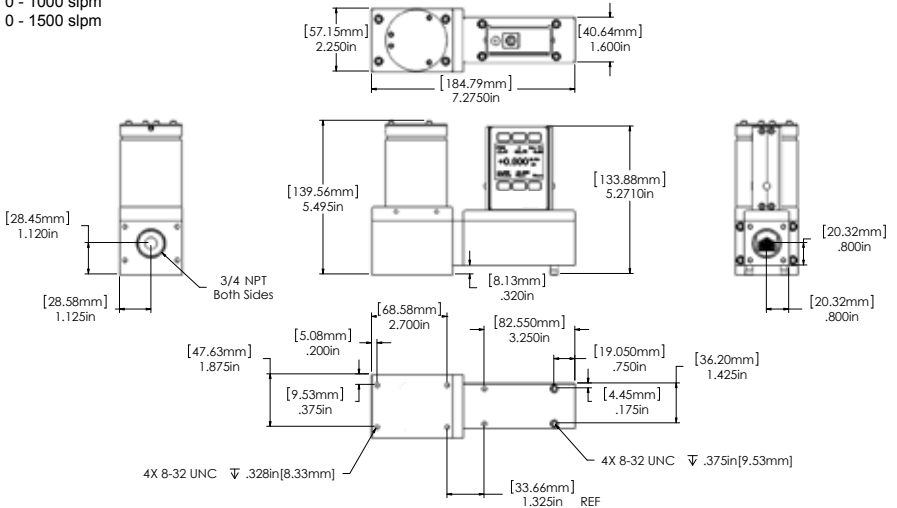

1500 slpm approximate weight: 9.0 lb.

FMA-2600A
0 - 2000 slpm

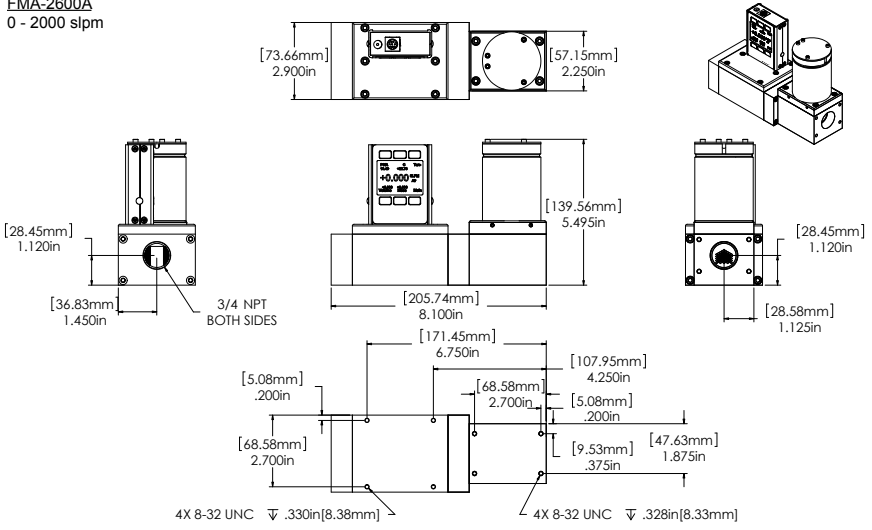

2000 slpm approximate weight: 12.0 lb.

FMA-2600A
0 - 3000 slpm

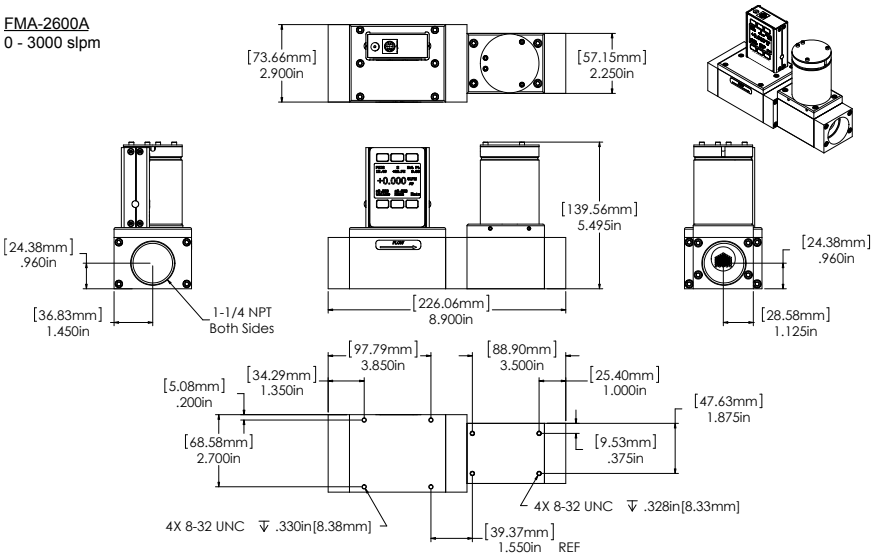

3000 slpm approximate weight: 12.0 lb.

Technical Data for FMA-LP2600A Low Pressure Drop Mass Flow Controllers
0 to 0.5 sccm Full Scale through 0 to 500 slpm Full Scale
Standard Specifications (Contact Omega for available options.)

Performance	FMA-LP2600A Mass Flow Controller
Accuracy at calibration conditions after tare	± (0.8% of Reading + 0.2% of Full Scale)
High Accuracy at calibration conditions after tare	± (0.4% of Reading + 0.2% of Full Scale) High Accuracy option not available for units ranged under 5 sccm or over 500 slpm.
Repeatability	± 0.2% Full Scale
Zero Shift and Span Shift	0.02% Full Scale / °Celsius / Atm
Operating Range / Turndown Ratio	0.5% to 100% Full Scale / 200:1 Turndown
Maximum Controllable Flow Rate	102.4% Full Scale
Typical Response Time	100 ms (Adjustable)
Warm-up Time	< 1 Second

Operating Conditions	FMA-LP2600A Mass Flow Controller
Mass Reference Conditions (STP)	25°C & 14.696 psia (standard — others available on request)
Operating Temperature	-10 to +50 °Celsius
Humidity Range (Non-Condensing)	0 to 100%
Maximum Pressure	50 psig Higher line pressures available, please contact Omega.
Mounting Attitude Sensitivity	Small Valve: None Large Valve: Mount with valve cylinder vertical & upright
Valve Type	Normally Closed
Ingress Protection	IP40
Wetted Materials	Small Valve: 303 & 302 Stainless Steel, FKM, Silicone RTV (Rubber), Glass Reinforced Nylon, Aluminum, Brass, 430FR Stainless Steel, Silicon, Glass. Large Valve: 303 & 302 Stainless Steel, FKM, Silicone RTV (Rubber), Glass Reinforced Nylon, Aluminum, 416 Stainless Steel, Nickel, Silicon, Glass. If your application demands a different material, please contact Omega.

Communications / Power	FMA-LP2600A Mass Flow Controller
Monochrome LCD Display with integrated touchpad	Simultaneously displays Mass Flow, Volumetric Flow, Pressure and Temperature
Digital Input/Output Signal ¹ Options	RS232 Serial / RS485 Serial
Analog Input/Output Signal ² Options	0-5 Vdc / 1-5 Vdc / 0-10 Vdc / 4-20 mA
Optional Secondary Analog Input/Output Signal ²	0-5 Vdc / 1-5 Vdc / 0-10 Vdc / 4-20 mA
Electrical Connection Options	8 Pin Mini-DIN /15-pin D-sub (DB15)
Supply Voltage	Small Valve: 12 to 30 Vdc (15-30 Vdc for 4-20 mA outputs) Large Valve: 24 to 30 Vdc
Supply Current	Small Valve: 0.250 Amp Large Valve: 0.750 Amp
1. The Digital Output Signal communicates Mass Flow, Volumetric Flow, Pressure and Temperature 2. The Analog Output Signal and Optional Secondary Analog Output Signal communicate your choice of Mass Flow, Volumetric Flow, Pressure or Temperature	

Range Specific Specifications

Full Scale Flow Mass Controller	Pressure Drop at FS Flow (psid) venting to atmosphere	Mechanical Dimensions	Process Connections ¹
0.5 sccm to 2 sccm	0.06	3.9"H x 3.4"W x 1.1"D	M-5 (10-32) Female Thread
5 sccm to 10 sccm	0.08		
20 sccm	0.07		
50 sccm to 200 sccm	0.07		
500 sccm	0.08	4.1"H x 3.6"W x 1.1"D	1/8" NPT Female
1 slpm	0.10		
2 slpm	0.18		
5 slpm	0.10		
10 slpm	0.12	5.5"H x 7.7"W x 2.3"D	1/4" NPT Female
20 slpm	0.26		
40 slpm	0.14		
50 slpm	0.17		
100 slpm	0.30	5.5"H x 7.3"W x 2.3"D	3/4" NPT Female
250 slpm	0.69		
500 slpm	0.69		
		5.5"H x 8.1"W x 2.7"D	3/4" NPT Female

1. Compatible with, Swagelok® tube, Parker®, face seal, push connect and compression adapter fittings. VCR and SAE connections upon request.

FMA-LP2600A

- 0 - 0.5 sccm
- 0 - 1 sccm
- 0 - 2 sccm
- 0 - 5 sccm
- 0 - 10 sccm
- 0 - 20 sccm

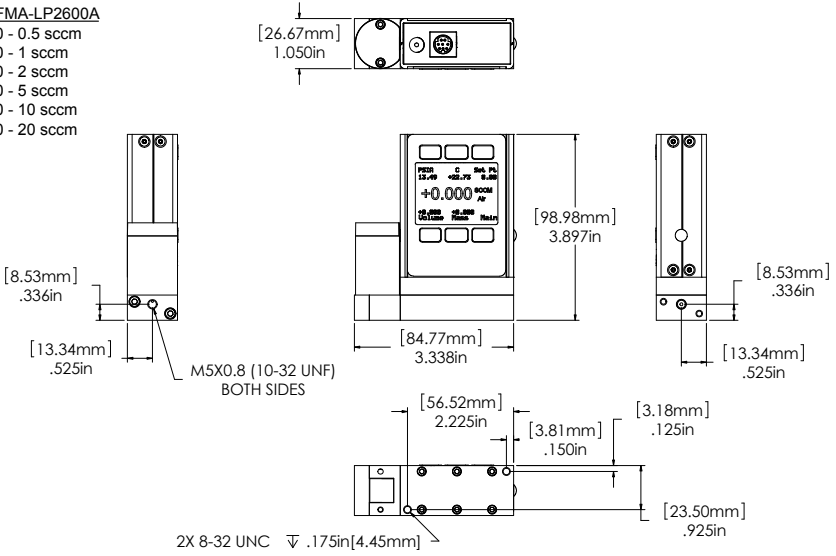

0.5 sccm to 20 sccm approximate shipping weight: 1.1 lb.

FMA-LP2600A

- 0 - 50 sccm
- 0 - 100 sccm
- 0 - 200 sccm
- 0 - 500 sccm
- 0 - 1 slpm
- 0 - 2 slpm

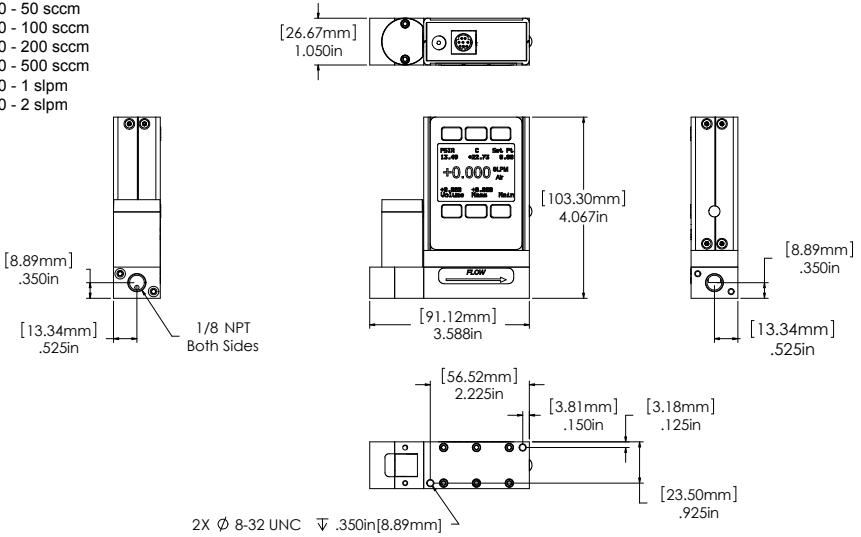

50 sccm to 2 slpm approximate weight: 1.2lb

FMA-LP2600A

- 0 - 5 slpm
- 0 - 10 slpm
- 0 - 20 slpm

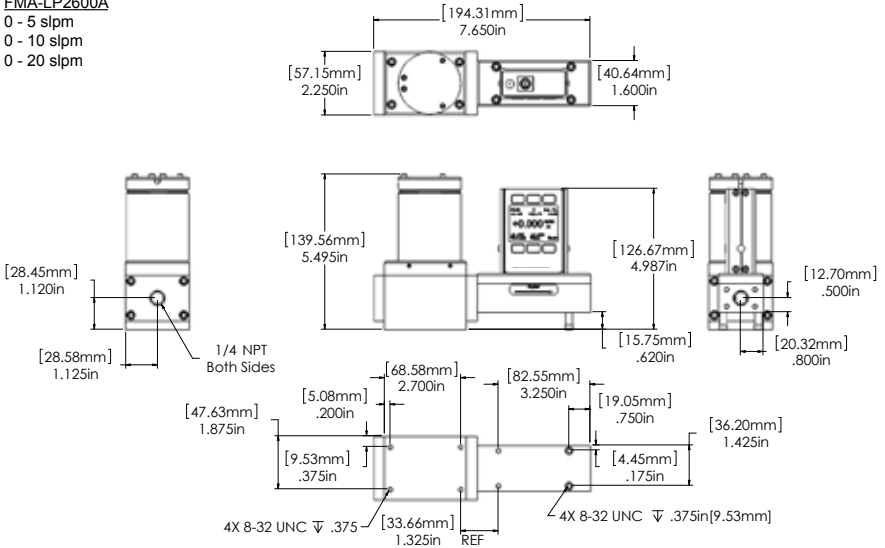

5 slpm to 20 slpm approximate weight: 6.4 lb.

FMA-LP2600A

- 0 - 40 slpm

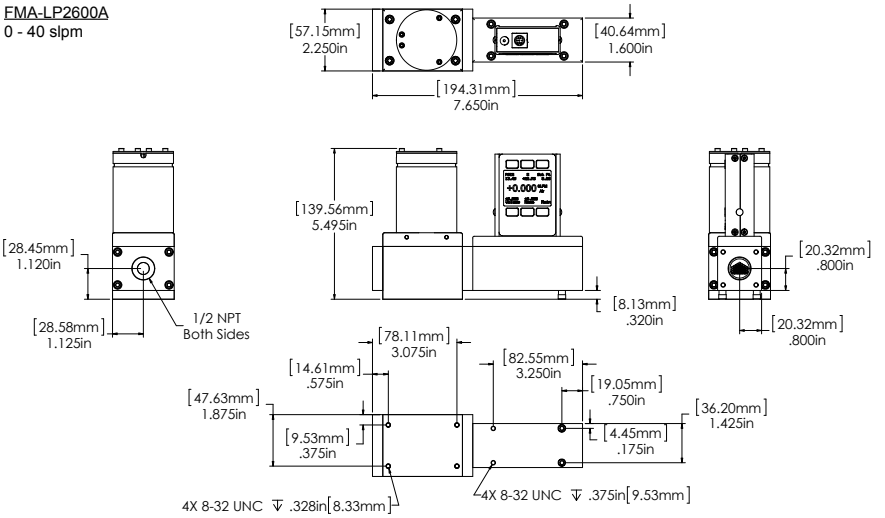

40 slpm approximate weight: 9.0 lb.

FMA-LP2600A

- 0 - 50 slpm
- 0 - 100 slpm
- 0 - 250 slpm

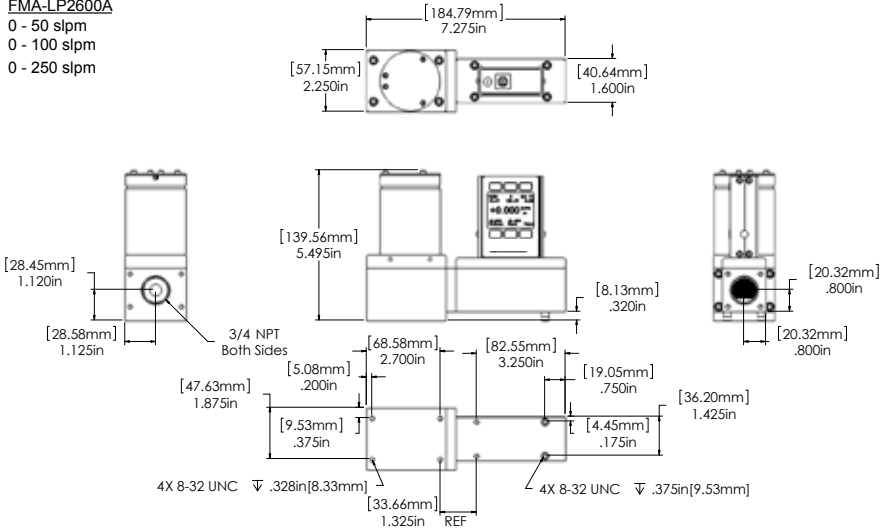

50 slpm to 250 slpm approximate weight: 9.0 lb.

FMA-LP2600A

- 0 - 500 slpm

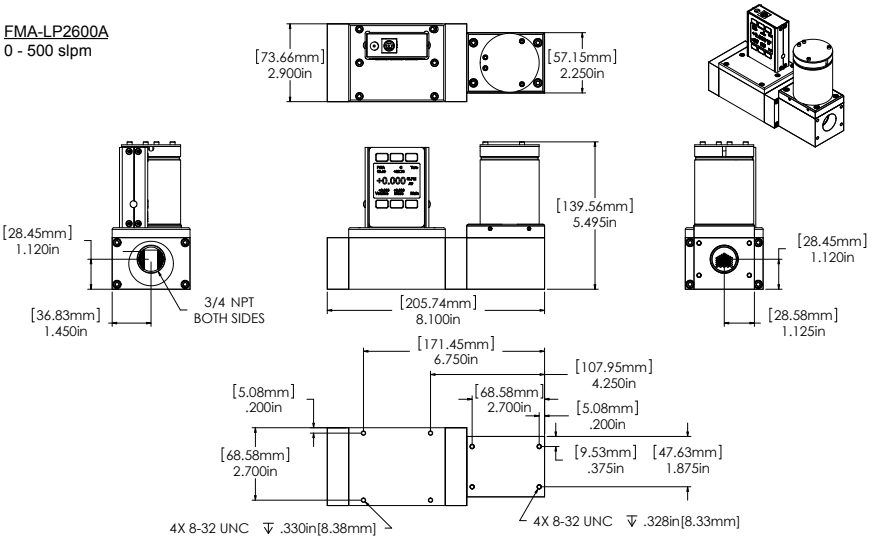

500 slpm approximate weight: 11.0 lb.

Technical Data for FMA-2600A-P & FMA-2600A-P-LSS Mass Flow Controllers

0 to 0.5 sccm Full Scale through 0 to 20 slpm Full Scale

The **FMA-2600A-P** mass flow controller is designed for applications that require tight shut-off such as vacuum coating and sputtering processes. An integrated pneumatic shut-off valve is normally closed and provides positive shut-off of 1×10^{-9} atm scc/sec Helium max.

FMA-2600A-P-LSS controllers are for use with some aggressive gases (page 64).

Standard Specifications (Contact Omega for available options.)

Performance	FMA-2600A-P Mass Flow Controller	FMA-2600A-P-LSS Mass Flow Controller
Accuracy at calibration conditions after tare	\pm (0.8% of Reading + 0.2% of Full Scale)	
High Accuracy at calibration conditions after tare	\pm (0.4% of Reading + 0.2% of Full Scale) High Accuracy option not available for units ranged under 5 sccm.	
Repeatability	\pm 0.2% Full Scale	
Zero Shift and Span Shift	0.02% Full Scale / °Celsius / Atm	
Operating Range / Turndown Ratio	0.5% to 100% Full Scale / 200:1 Turndown	1% to 100% Full Scale / 100:1 Turndown
Maximum Controllable Flow Rate	102.4% Full Scale	
Typical Response Time	100 ms (Adjustable)	
Warm-up Time	< 1 Second	
Integrated Valve Leak Integrity	1×10^{-9} atm scc/sec Helium max	

Operating Conditions	FMA-2600A-P Mass Flow Controller	FMA-2600A-P-LSS Mass Flow Controller
Mass Reference Conditions (STP)	25°C & 14.696 psia (standard — others available on request)	
Operating Temperature	-10 to +50 °Celsius	
Humidity Range (Non-Condensing)	0 to 100%	
Maximum Pressure	145 psig	
Mounting Attitude Sensitivity	None	
Valve Type	Normally Closed	
Ingress Protection	IP40	
Wetted Materials	FMA-2600A-P: 303 & 302 Stainless Steel, FKM, Heat Cured Silicone Rubber, Glass Reinforced Polyphenylene Sulfide, Heat Cured Epoxy, Aluminum, Gold, Brass, 430FR Stainless Steel, Silicon, Glass. FMA-2600A-P-LSS: 316LSS, 303SS, 430FRSS, Perfluoroelastomer standard, FKM, EPDM, Buna, Neoprene as needed for some gases. If your application demands a different material, please contact Omega.	

Communications / Power	FMA-2600A-P & FMA-2600A-P-LSS Mass Flow Controller
Monochrome LCD Display with integrated touchpad	Simultaneously displays Mass Flow, Volumetric Flow, Pressure and Temperature
Digital Input/Output Signal ¹ Options	RS232 Serial / RS485 Serial
Analog Input/Output Signal ² Options	0-5 Vdc / 1-5 Vdc / 0-10 Vdc / 4-20 mA
Optional Secondary Analog Input/Output Signal ²	0-5 Vdc / 1-5 Vdc / 0-10 Vdc / 4-20 mA
Electrical Connection Options	8 Pin Mini-DIN / 15-pin D-sub (DB15)
Supply Voltage	12 to 30 Vdc (15-30 Vdc for 4-20 mA outputs)
Supply Current	0.250 Amp
1. The Digital Output Signal communicates Mass Flow, Volumetric Flow, Pressure and Temperature 2. The Analog Output Signal and Optional Secondary Analog Output Signal communicate your choice of Mass Flow, Volumetric Flow, Pressure or Temperature	

Range Specific Specifications

Full Scale Mass Flow Controller	Mechanical Dimensions	Process Connections
FMA-2600A-P 0.5SCCM to 20SLPM	4.8"H x 6.8"W x 1.5"D	1/4" VCR® Male
FMA-2600A-P-LSS 0.5SCCM to 20SLPM	5.5"H x 6.8"W x 1.5"D	1/4" VCR® Male
Welded VCR® process connections are recommended for FMA-2600A-P and FMA-2600A-P-LSS applications. Please contact Omega.		

FMA-2600A-P

All ranges

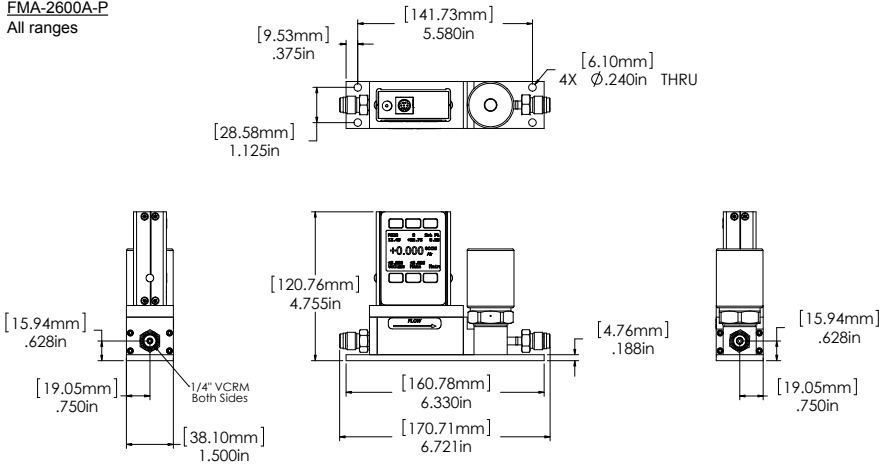

FMA-2600A-P approximate weight: 3.0 lb.

FMA-2600A-P-LSS

All ranges

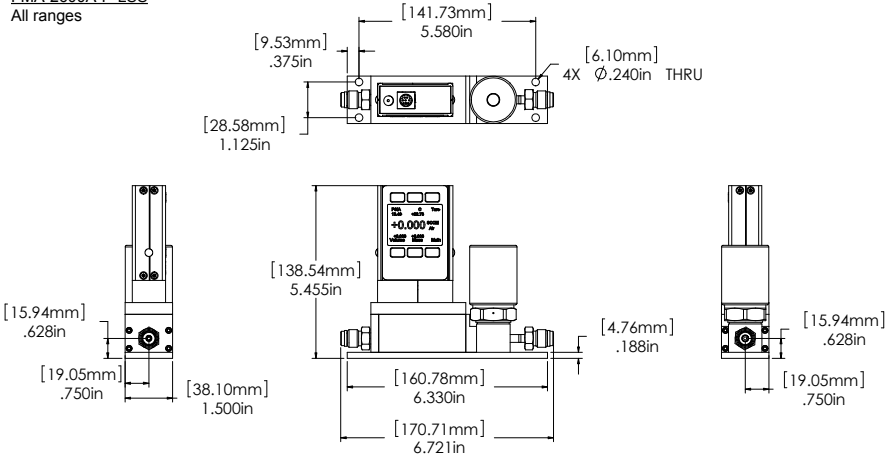

FMA-2600A-P-LSS approximate weight: 3.2 lb.

Technical Data for FMA-2600A-LSS Mass Flow Controllers

FMA-2600A-LSS instruments are built for use with aggressive gases. For the most part, these instruments maintain the specifications of equivalently ranged FMA-2600A devices.

Standard Compatible Gas List for FMA-2600A-LSS Controllers

0	Air	Air
1	Argon	Ar
2	Methane	CH4
3	Carbon Monoxide	CO
4	Carbon Dioxide	CO2
5	Ethane	C2H6
6	Hydrogen	H2
7	Helium	He
8	Nitrogen	N2
9	Nitrous Oxide	N2O
10	Neon	Ne
11	Oxygen	O2
12	Propane	C3H8
13	normal-Butane	n-C4H10
14	Acetylene	C2H2
15	Ethylene	C2H4
16	iso-Butane	i-C4H10
17	Krypton	Kr
18	Xenon	Xe
19	Sulfur Hexafluoride	SF6
20	75%Ar / 25% CO2	C-25
21	90% Ar / 10% CO2	C-10
22	92% Ar / 8% CO2	C-8

23	98% Ar / 2% CO2	C-2
24	75% CO2 / 25% Ar	C-75
25	75% Ar / 25% He	A-75
26	75% He / 25% Ar	A-25
27	90% He / 7.5% Ar / 2.5% CO2 Helistar® A1025	A1025
28	90% Ar / 8% CO2 / 2% O2 Stargon® CS	Star29
29	95% Ar / 5% CH4	P-5
30	Nitric Oxide	NO
31	Nitrogen Trifluoride	NF3
32	Ammonia	NH3
34	Hydrogen Sulfide	H2S
36	Propylene	C3H6
In addition, the following gases are available upon request:		
Nitrogen Dioxide to 0.5% in an inert carrier		NO2
Refrigerant gases to 100%		
Other gases to 1000 ppm in an inert carrier		

If your application requires another gas or gas mixture, please contact Omega.

Please refer to the Technical Data and Specifications for the equivalently ranged FMA-2600A instrument for all operating specifications except:

Operating Range	1% to 100% Full Scale
Turndown Ratio	100 : 1
Wetted Materials	316LSS, 303SS, 430FRSS, Perfluoroelastomer standard, FKM, EPDM as needed for some gases.

The dimensions of FMA-2600A-LSS instruments may vary from their standard FMA-2600A counterparts. Dimensional drawings for FMA-2600A-LSS instruments are shown on pages 68 -71

FMA-2600A-LSS

- 0 – 0.5 sccm
- 0 – 1 sccm
- 0 – 2 sccm
- 0 – 5 sccm
- 0 – 10 sccm
- 0 – 20 sccm
- 0 – 50 sccm

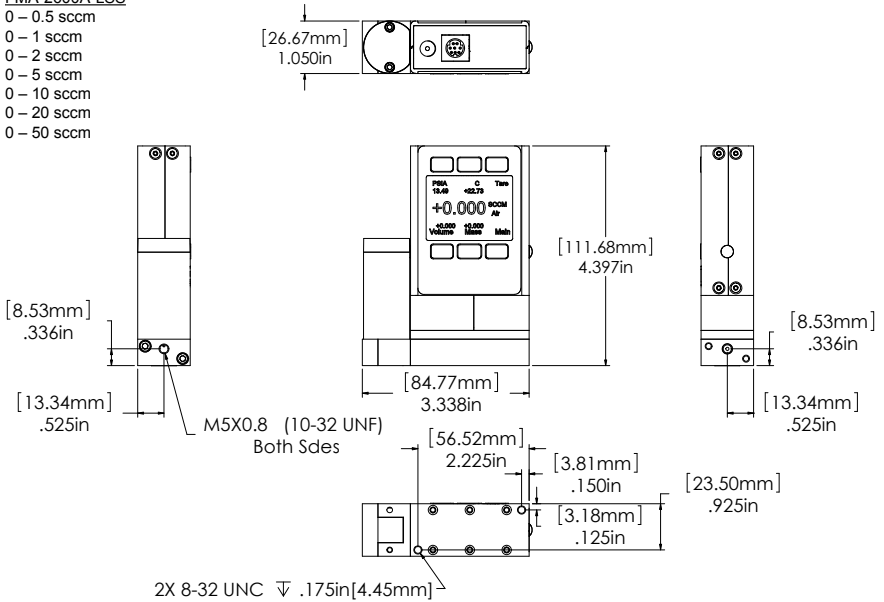

0.5 sccm to 50 sccm approximate shipping weight: 1.1 lb.

FMA-2600A-LSS

- 0 – 100 sccm
- 0 – 200 sccm
- 0 – 500 sccm
- 0 – 1 slpm
- 0 – 2 slpm
- 0 – 5 slpm
- 0 – 10 slpm
- 0 – 20 slpm

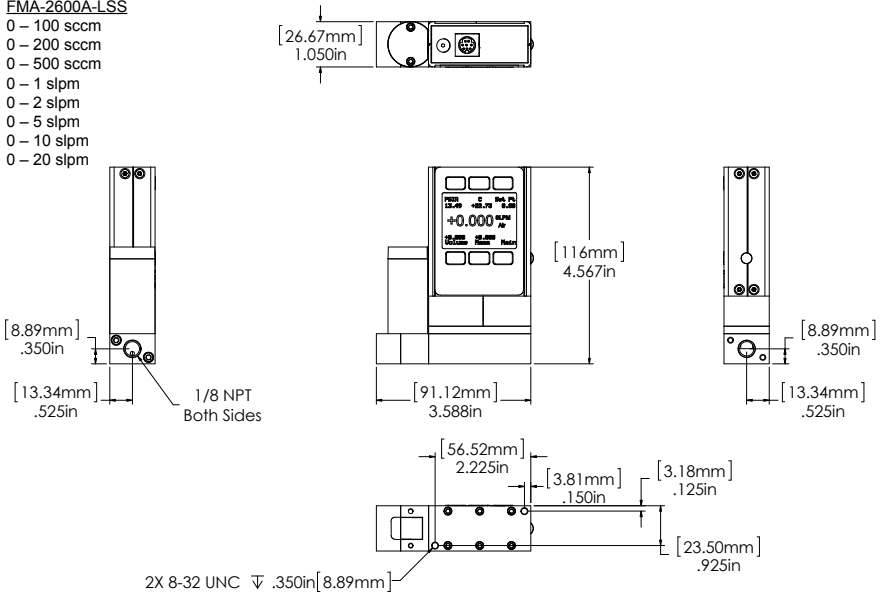

100 sccm to 20 slpm approximate weight: 1.2 lb

FMA-2600A-LSS

0 – 50 slpm
0 – 100 slpm

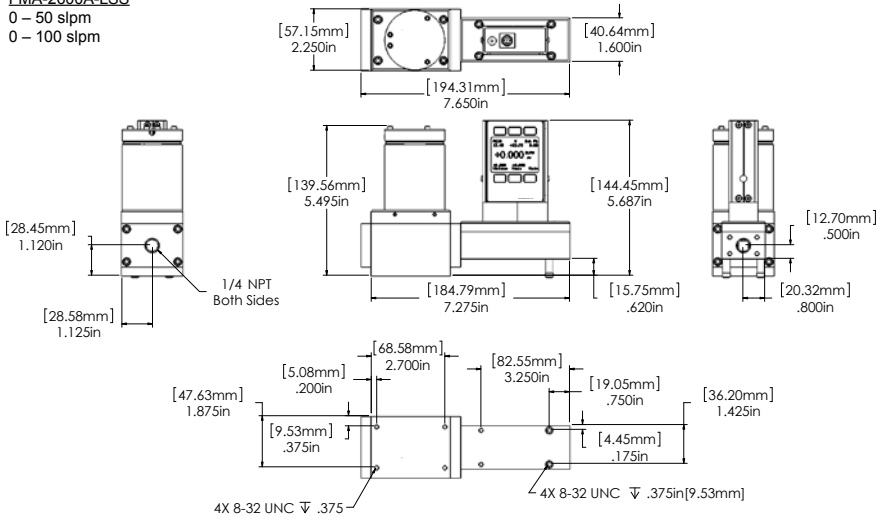

50 slpm to 100 slpm approximate weight: 9.0 lb.

FMA-2600A-LSS

0 – 250 slpm

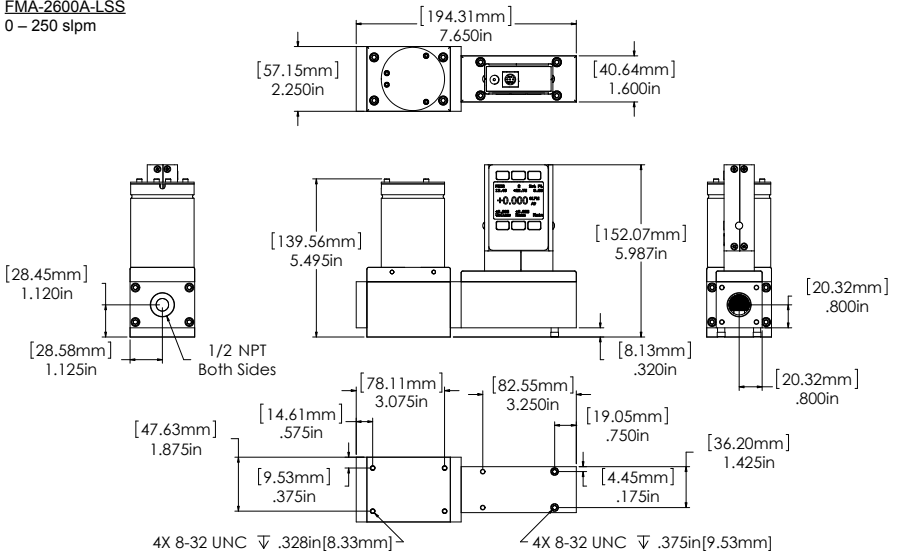

250 slpm approximate weight: 9.0 lb.

FMA-2600A-LSS

0 – 500 slpm
 0 – 1000 slpm
 0 – 1500 slpm

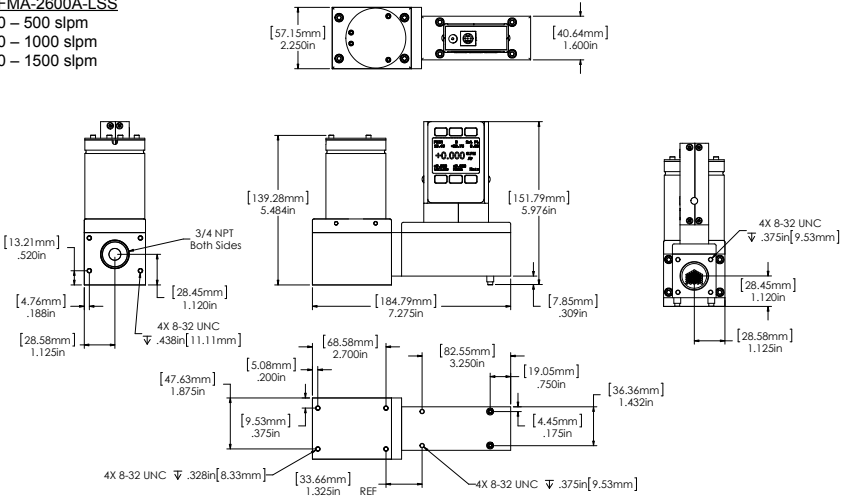

500 slpm to 1500 slpm approximate weight: 9.0 lb.

FMA-2600A-LSS

0 – 2000 slpm

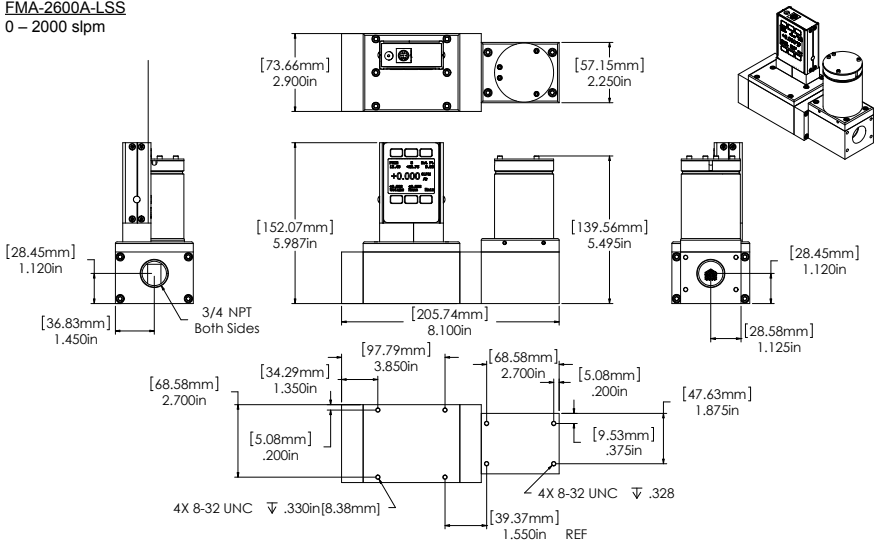

2000 slpm approximate weight: 12.0 lb.

FMA-2600A-LSS
 0 – 3000 slpm

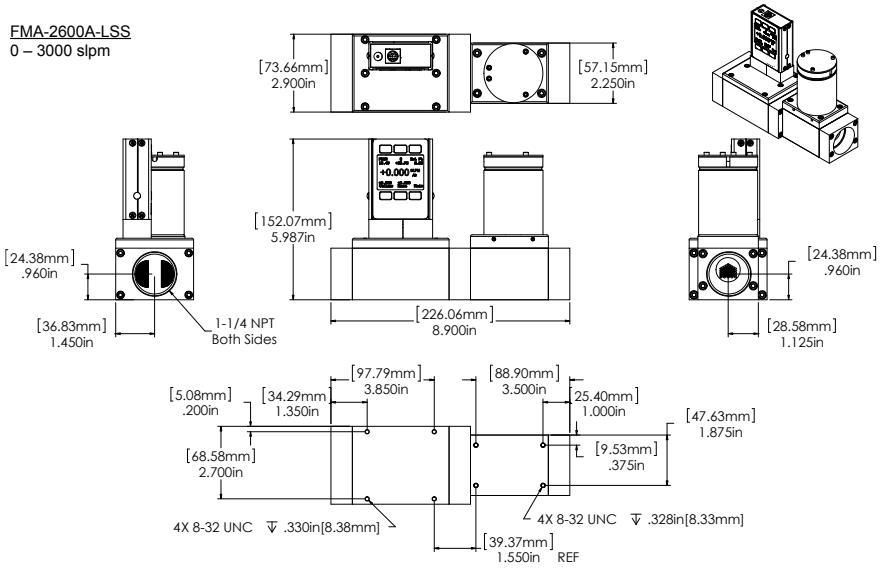

3000 slpm approximate weight: 12.0 lb.

Eight Pin Mini-DIN Connector Pin-Outs

If your FMA-2600A instrument was ordered with the standard Eight Pin Mini-DIN connection, please be sure to reference the following pin-out diagram.

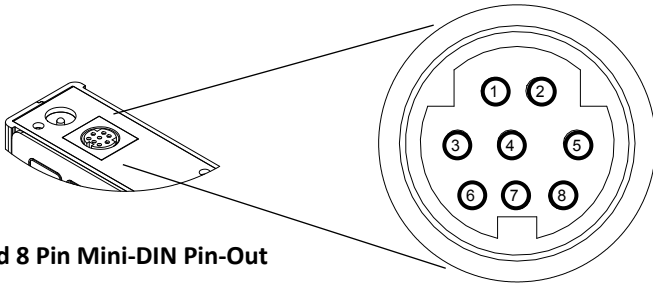

Standard 8 Pin Mini-DIN Pin-Out

Pin	Function	Mini-DIN cable color
1	Inactive (or optional 4-20mA Primary Output Signal)	Black
2	Static 5.12 Vdc [or optional Secondary Analog Output (4-20mA, 5Vdc, 10Vdc) or Basic Alarm]	Brown
3	Serial RS232RX / RS485(-) Input Signal (receive)	Red
4	Meters = Remote Tare (Ground to Tare) Controllers = Analog Set-Point Input	Orange
5	Serial RS232TX / RS485(+) Output Signal (send)	Yellow
6	0-5 Vdc (or optional 0-10 Vdc) Output Signal	Green
7	Power In	Blue
8	Ground (common for power, digital communications, analog signals and alarms)	Purple

Note: The above pin-out is applicable to all the flow meters and controllers with the Mini-DIN connector. The availability of different output signals depends on the options ordered. Optional configurations are noted on the unit's calibration sheet.

DB15 Pin-Outs

If your instrument was ordered with a DB15 connection, be sure to check the Calibration Label on the device and reference the appropriate pin-out diagram.

The following pin-out chart describes the safest and generally compatible arrangement when connecting a non-FMA-2600A Series DB15 wire to a DB15 equipped FMA-2600A Series. Not all features may be available between brands, but the common denominators are featured in our DB15 offerings, along with some options for customization.

DB15

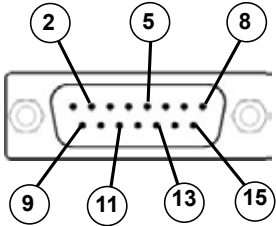

Male Connector Front View

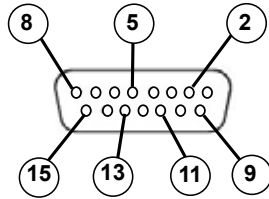

Female Connector Front View

Pin Number	Function
1	Ground
2	Primary Analog Signal Output
3	Ground
4	N/C
5	Power Supply (+Vdc)
6	N/C
7	N/C
8	Analog Tare (meters — when grounded) Analog Set-Point Input (controllers)
9	Power Supply Common
10	Ground
11	Secondary Analog Signal Output / fixed 5.12Vdc
12	N/C
13	RS232 RX (receive) or RS485 –
14	Ground
15	RS232 TX (send) or RS485 +

Check your device's calibration certificate and user manual for the actual electrical input/output requirements, as all instruments are custom configured to some extent.

NOTE: Pins 1, 3, 9, 10, and 14 are connected together inside of the device and are common grounding points.

N/C = Not Connected/Open (can be used for custom pin assignments – please consult factory).

DB15 Pin-Outs

If your instrument was ordered with a DB15 connection, be sure to check the Calibration Label on the device and reference the appropriate pin-out diagram.

The following pin-out chart describes the safest and generally compatible arrangement when connecting a non-FMA-2600A Series DB15 wire to a DB15 equipped FMA-2600A Series. Not all features may be available between brands, but the common denominators are featured in our DB15 offerings, along with some options for customization.

DB15A (XFM)

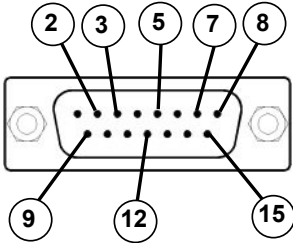

Male Connector Front View

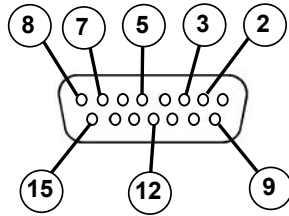

Female Connector Front View

Pin Number	Function
1	Ground
2	Primary Analog Signal Output
3	Analog Tare (meters — when grounded)* Analog Set-Point Input (controllers)*
4	Ground
5	Power Supply Common
6	Ground
7	Power Supply (+Vdc)
8	RS232 Tx (send) / RS485 –
9	Ground
10	N/C
11	N/C
12	Secondary Analog Signal Output / fixed 5.12Vdc*
13	N/C
14	N/C
15	RS232 Rx (receive) / RS485 +

Check your device's calibration certificate and user manual for the actual electrical input/output requirements, as all instruments are custom configured to some extent.

NOTE: Pins 1, 4, 5, 6 and 9 are connected together inside of the device and are common grounding points.

N/C = Not Connected/Open (can be used for custom pin assignments – please consult factory).

* Added to allow for full use of features on FMA-2600A devices, may not be present on host wiring.

DB15 Pin-Outs

If your instrument was ordered with a DB15 connection, be sure to check the Calibration Label on the device and reference the appropriate pin-out diagram.

The following pin-out chart describes the safest and generally compatible arrangement when connecting a non-FMA-2600A Series DB15 wire to a DB15 equipped FMA-2600A Series. Not all features may be available between brands, but the common denominators are featured in our DB15 offerings, along with some options for customization.

DB15B

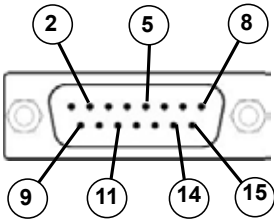

Male Connector Front View

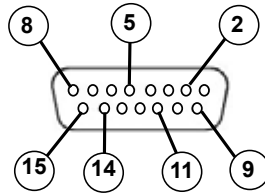

Female Connector Front View

Pin Number	Function
1	Ground
2	Primary Analog Signal Output
3	N/C
4	N/C
5	Power Supply (+Vdc)
6	N/C
7	N/C
8	Analog Tare (meters — when grounded)* Analog Set-Point Input (controllers)*
9	Power Supply Common
10	Ground
11	Secondary Analog Signal Output / fixed 5.12Vdc
12	N/C
13	N/C
14	RS232 RX (receive) or RS485 —*
15	RS232 TX (send) or RS485 +*

Check your device's calibration certificate and user manual for the actual electrical input/output requirements, as all instruments are custom configured to some extent.

NOTE: Pins 1, 9, and 10 are connected together inside of the device and are common grounding points.

N/C = Not Connected/Open (can be used for custom pin assignments — please consult factory)

* Added to allow for full use of features on FMA-2600A devices, may not be present on host wiring.

DB15 Pin-Outs

If your instrument was ordered with a DB15 connection, be sure to check the Calibration Label on the device and reference the appropriate pin-out diagram.

The following pin-out chart describes the safest and generally compatible arrangement when connecting a non-FMA-2600A Series DB15 wire to a DB15 equipped FMA-2600A Series. Not all features may be available between brands, but the common denominators are featured in our DB15 offerings, along with some options for customization.

DB15K

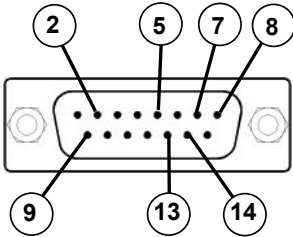

Male Connector Front View

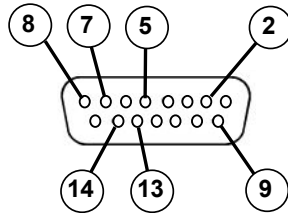

Female Connector Front View

Pin Number	Function
1	N/C
2	Primary Analog Signal Output
3	N/C
4	N/C
5	Power Supply Common
6	N/C
7	Power Supply (+Vdc)
8	Analog Tare (meters — when grounded) Analog Set-Point Input (controllers)
9	Secondary Analog Signal Output / fixed 5.12Vdc *
10	N/C
11	Ground
12	Ground
13	RS232 RX (receive) or RS485 - *
14	RS232 TX (send) or RS485 + *
15	Ground

Check your device's calibration certificate and user manual for the actual electrical input/output requirements, as all instruments are custom configured to some extent.

NOTE: Pins 5, 11, 12 and 15 are connected together inside of the device and are common grounding points.

N/C = Not Connected/Open (can be used for custom pin assignments – please consult factory).

* Added to allow for full use of features on FMA-2600A devices, may not be present on host wiring.

DB15 Pin-Outs

If your instrument was ordered with a DB15 connection, be sure to check the Calibration Label on the device and reference the appropriate pin-out diagram.

The following pin-out chart describes the safest and generally compatible arrangement when connecting a non-FMA-2600A Series DB15 wire to a DB15 equipped FMA-2600A Series. Not all features may be available between brands, but the common denominators are featured in our DB15 offerings, along with some options for customization.

DB15H

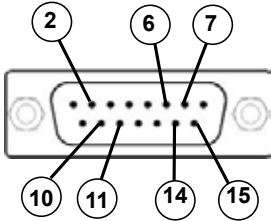

Male Connector Front View

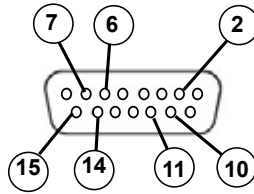

Female Connector Front View

Pin Number	Function
1	N/C
2	RS232 RX (receive) or RS485 – *
3	N/C
4	N/C
5	Ground
6	Primary Analog Signal Output
7	Power Supply Common
8	N/C
9	N/C
10	Secondary Analog Signal Output / fixed 5.12Vdc *
11	Power Supply (+Vdc)
12	Ground
13	N/C
14	Analog Tare (meters — when grounded) Analog Set-Point Input (controllers)
15	RS232 TX (send) or RS485 + *

Check your device's calibration certificate and user manual for the actual electrical input/output requirements, as all instruments are custom configured to some extent.

NOTE: Pins 5, 11, 12 and 15 are connected together inside of the device and are common grounding points.

N/C = Not Connected/Open (can be used for custom pin assignments – please consult factory).

* Added to allow for full use of features on FMA-2600A devices, may not be present on host wiring.

DB15 Pin-Outs

If your instrument was ordered with a DB15 connection, be sure to check the Calibration Label on the device and reference the appropriate pin-out diagram.

The following pin-out chart describes the safest and generally compatible arrangement when connecting a non-FMA-2600A Series DB15 wire to a DB15O equipped FMA-2600A Series. Not all features may be available between brands, but the common denominators are featured in our DB15 offerings, along with some options for customization.

DB15O

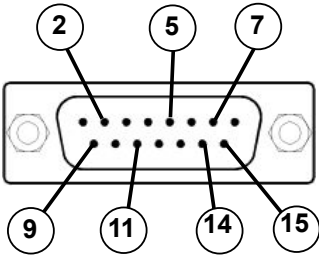

Male Connector Front View

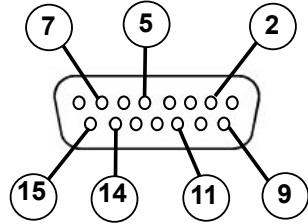

Female Connector Front View

Pin Number	Function
1	Ground
2	N/C
3	N/C
4	Primary Analog Signal Output
5	Power Supply (+Vdc)
6	N/C
7	Analog Tare (meters — when grounded)* Analog Set-Point Input (controllers)*
8	N/C
9	Power Supply Common
10	Ground
11	Secondary Analog Signal Output / fixed 5.12Vdc
12	N/C
13	N/C
14	RS232 RX (receive) or RS485 —*
15	RS232 TX (send) or RS485 +*

Check your device's calibration certificate and user manual for the actual electrical input/output requirements, as all instruments are custom configured to some extent.

NOTE: Pins 1, 9, and 10 are connected together inside of the device and are common grounding points.

N/C = Not Connected/Open (can be used for custom pin assignments – please consult factory)

* Added to allow for full use of features on FMA-2600A devices, may not be present on host wiring.

DB15 Pin-Outs

If your instrument was ordered with a DB15 connection, be sure to check the Calibration Label on the device and reference the appropriate pin-out diagram.

The following pin-out chart describes the safest and generally compatible arrangement when connecting a non-FMA-2600A Series DB15 wire to a DB15 equipped FMA-2600A Series. Not all features may be available between brands, but the common denominators are featured in our DB15 offerings, along with some options for customization.

DB15S

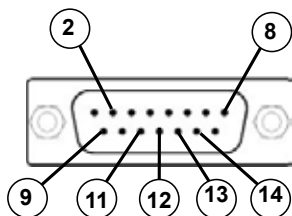

Male Connector Front View

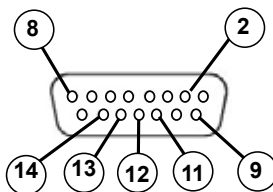

Female Connector Front View

Pin Number	Function
1	Ground
2	Primary Analog Signal Output
3	N/C
4	N/C
5	Ground
6	N/C
7	N/C
8	Analog Tare (meters — when grounded) Analog Set-Point Input (controllers)
9	Power Supply Common
10	Ground
11	Secondary Analog Signal Output / fixed 5.12Vdc *
12	RS232 RX (receive) or RS485 - *
13	Power Supply (+Vdc)
14	RS232 TX (send) or RS485 + *
15	Ground

Check your device's calibration certificate and user manual for the actual electrical input/output requirements, as all instruments are custom configured to some extent.

NOTE: Pins 1, 5, 9, 10 and 15 are connected together inside of the device and are common grounding points.

N/C = Not Connected/Open (can be used for custom pin assignments – please consult factory).

* Added to allow for full use of features on FMA-2600A devices, may not be present on host wiring.

WARRANTY/DISCLAIMER

OMEGA ENGINEERING, INC. warrants this unit to be free of defects in materials and workmanship for a period of **13 months** from date of purchase. OMEGA's WARRANTY adds an additional one (1) month grace period to the normal **one (1) year product warranty** to cover handling and shipping time. This ensures that OMEGA's customers receive maximum coverage on each product.

If the unit malfunctions, it must be returned to the factory for evaluation. OMEGA's Customer Service Department will issue an Authorized Return (AR) number immediately upon phone or written request. Upon examination by OMEGA, if the unit is found to be defective, it will be repaired or replaced at no charge. OMEGA's WARRANTY does not apply to defects resulting from any action of the purchaser, including but not limited to mishandling, improper interfacing, operation outside of design limits, improper repair, or unauthorized modification. This WARRANTY is VOID if the unit shows evidence of having been tampered with or shows evidence of having been damaged as a result of excessive corrosion; or current, heat, moisture or vibration; improper specification; misapplication; misuse or other operating conditions outside of OMEGA's control. Components in which wear is not warranted, include but are not limited to contact points, fuses, and triacs.

OMEGA is pleased to offer suggestions on the use of its various products. However, OMEGA neither assumes responsibility for any omissions or errors nor assumes liability for any damages that result from the use of its products in accordance with information provided by OMEGA, either verbal or written. OMEGA warrants only that the parts manufactured by the company will be as specified and free of defects. OMEGA MAKES NO OTHER WARRANTIES OR REPRESENTATIONS OF ANY KIND WHATSOEVER, EXPRESSED OR IMPLIED, EXCEPT THAT OF TITLE, AND ALL IMPLIED WARRANTIES INCLUDING ANY WARRANTY OF MERCHANTABILITY AND FITNESS FOR A PARTICULAR PURPOSE ARE HEREBY DISCLAIMED. LIMITATION OF LIABILITY: The remedies of purchaser set forth herein are exclusive, and the total liability of OMEGA with respect to this order, whether based on contract, warranty, negligence, indemnification, strict liability or otherwise, shall not exceed the purchase price of the component upon which liability is based. In no event shall OMEGA be liable for consequential, incidental or special damages.

CONDITIONS: Equipment sold by OMEGA is not intended to be used, nor shall it be used: (1) as a "Basic Component" under 10 CFR 21 (NRC), used in or with any nuclear installation or activity; or (2) in medical applications or used on humans. Should any Product(s) be used in or with any nuclear installation or activity, medical application, used on humans, or misused in any way, OMEGA assumes no responsibility as set forth in our basic WARRANTY/DISCLAIMER language, and, additionally, purchaser will indemnify OMEGA and hold OMEGA harmless from any liability or damage whatsoever arising out of the use of the Product(s) in such a manner.

RETURN REQUESTS/INQUIRIES

Direct all warranty and repair requests/inquiries to the OMEGA Customer Service Department. BEFORE RETURNING ANY PRODUCT(S) TO OMEGA, PURCHASER MUST OBTAIN AN AUTHORIZED RETURN (AR) NUMBER FROM OMEGA'S CUSTOMER SERVICE DEPARTMENT (IN ORDER TO AVOID PROCESSING DELAYS). The assigned AR number should then be marked on the outside of the return package and on any correspondence.

The purchaser is responsible for shipping charges, freight, insurance and proper packaging to prevent breakage in transit.

FOR **WARRANTY** RETURNS, please have the following information available BEFORE contacting OMEGA:

1. Purchase Order number under which the product was PURCHASED,
2. Model and serial number of the product under warranty, and
3. Repair instructions and/or specific problems relative to the product.

FOR **NON-WARRANTY** REPAIRS, consult OMEGA for current repair charges. Have the following information available BEFORE contacting OMEGA:

1. Purchase Order number to cover the COST of the repair,
2. Model and serial number of the product, and
3. Repair instructions and/or specific problems relative to the product.

OMEGA's policy is to make running changes, not model changes, whenever an improvement is possible. This affords our customers the latest in technology and engineering.

OMEGA is a registered trademark of OMEGA ENGINEERING, INC.

© Copyright 2015 OMEGA ENGINEERING, INC. All rights reserved. This document may not be copied, photocopied, reproduced, translated, or reduced to any electronic medium or machine-readable form, in whole or in part, without the prior written consent of OMEGA ENGINEERING, INC.

Where Do I Find Everything I Need for Process Measurement and Control? **OMEGA...Of Course!** *Shop online at omega.comSM*

TEMPERATURE

- ☑ Thermocouple, RTD & Thermistor Probes, Connectors, Panels & Assemblies
- ☑ Wire: Thermocouple, RTD & Thermistor
- ☑ Calibrators & Ice Point References
- ☑ Recorders, Controllers & Process Monitors
- ☑ Infrared Pyrometers

PRESSURE, STRAIN AND FORCE

- ☑ Transducers & Strain Gages
- ☑ Load Cells & Pressure Gages
- ☑ Displacement Transducers
- ☑ Instrumentation & Accessories

FLOW/LEVEL

- ☑ Rotameters, Gas Mass Flowmeters & Flow Computers
- ☑ Air Velocity Indicators
- ☑ Turbine/Paddlewheel Systems
- ☑ Totalizers & Batch Controllers

pH/CONDUCTIVITY

- ☑ pH Electrodes, Testers & Accessories
- ☑ Benchtop/Laboratory Meters
- ☑ Controllers, Calibrators, Simulators & Pumps
- ☑ Industrial pH & Conductivity Equipment

DATA ACQUISITION

- ☑ Data Acquisition & Engineering Software
- ☑ Communications-Based Acquisition Systems
- ☑ Plug-in Cards for Apple, IBM & Compatibles
- ☑ Data Logging Systems
- ☑ Recorders, Printers & Plotters

HEATERS

- ☑ Heating Cable
- ☑ Cartridge & Strip Heaters
- ☑ Immersion & Band Heaters
- ☑ Flexible Heaters
- ☑ Laboratory Heaters

ENVIRONMENTAL MONITORING AND CONTROL

- ☑ Metering & Control Instrumentation
- ☑ Refractometers
- ☑ Pumps & Tubing
- ☑ Air, Soil & Water Monitors
- ☑ Industrial Water & Wastewater Treatment
- ☑ pH, Conductivity & Dissolved Oxygen Instruments